

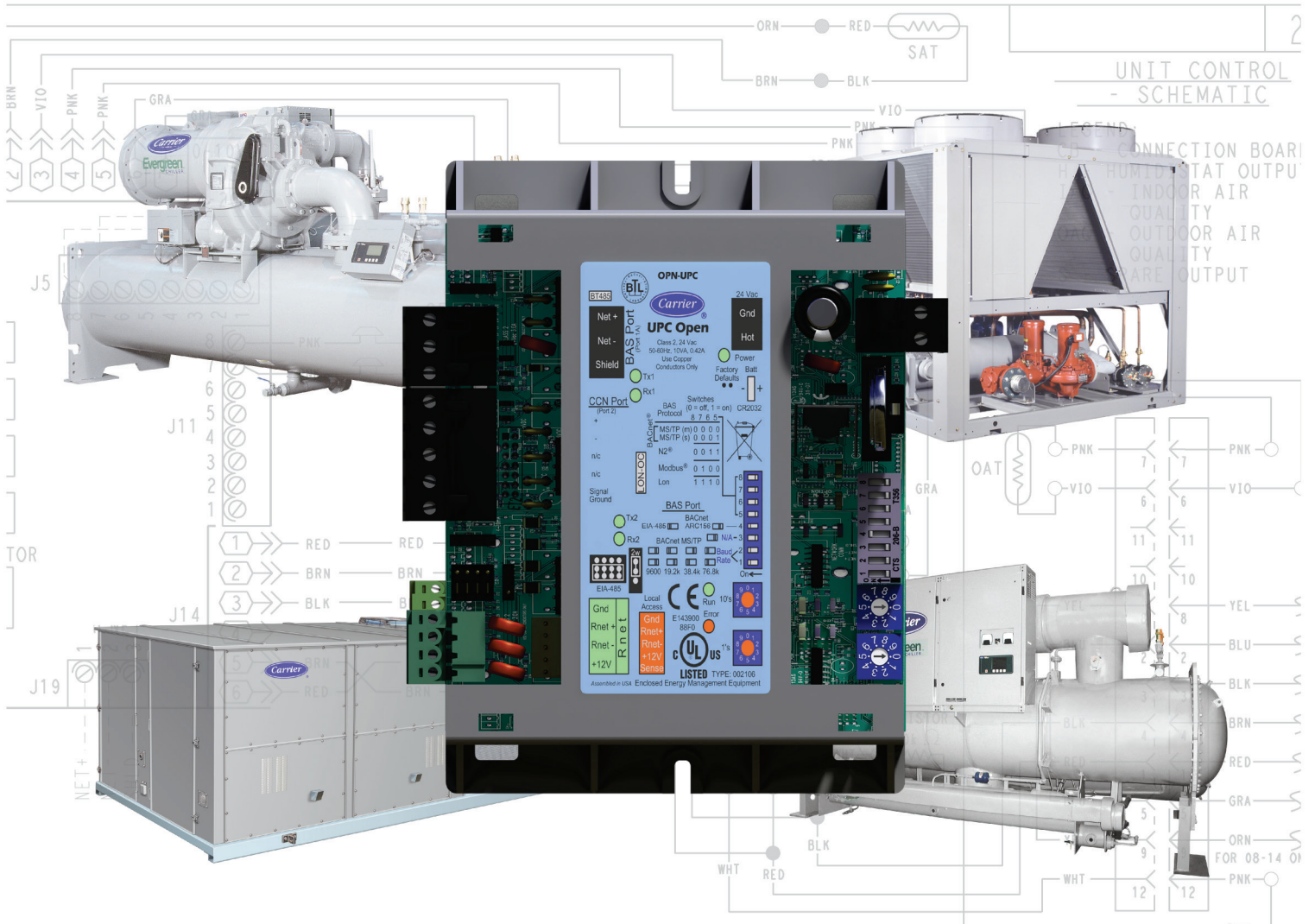

United Technologies
turn to the experts

UPC Open

Installation and Integration Guide





Verify that you have the most current version of this document from www.hvacpartners.com or your local Carrier office.

Important changes are listed in **Document revision history** at the end of this document.

CARRIER CORPORATION ©2017. All rights reserved throughout the world. i-Vu is a registered trademark of Carrier Corporation. All other trademarks are the property of their respective owners.

Contents

UPC Open overview and specifications	1
What is the UPC Open?.....	1
Specifications.....	2
Safety considerations.....	3
Installing the UPC Open	4
Mounting the UPC Open	4
Wiring the UPC Open for power.....	4
To wire for power.....	5
Addressing the UPC Open.....	5
Wiring for communications.....	5
Wiring specifications for BACnet MS/TP and ARC156.....	6
To wire the controller to the BACnet network.....	6
Wiring the UPC Open to the CCN network	7
Wiring specifications for CCN	7
To wire the CCN equipment to the UPC Open.....	8
Wiring devices to the UPC Open's Rnet port	8
Rnet wiring specifications.....	8
ZS Sensor overview	9
SPT sensor overview	9
To wire the ZS or SPT sensor to the UPC Open	10
Wireless sensor overview	10
To install the Wireless Adapter for wireless sensors.....	11
To wire an Equipment Touch to the UPC Open.....	12
Start-up	14
Select or create a custom control program and graphic for the UPC Open	14
To install the UPC Open into an i-Vu® Control System.....	15
Configure the UPC Open's properties	16
Troubleshooting	18
LED's	18
To get the serial number	19
To restore defaults.....	20
To replace the UPC Open's battery	20
Compliance	21
FCC Compliance	21
CE Compliance	21
BACnet Compliance.....	21
Appendix: Single Point Linkage and Device Address Binding	22
Single Point Linkage	22
Device Address Binding.....	23
Document revision history	24

UPC Open overview and specifications

What is the UPC Open?

The UPC Open (Universal Protocol Converter) is a general purpose protocol converter. The UPC Open can convert proprietary equipment data into open protocol data, enabling a stand-alone, single piece of equipment to reside on a BACnet network, where it can be monitored or controlled by a Building Automation System (BAS).

NOTE A future release of the UPC Open will support installation on a Modbus, N2, or LonWorks network.

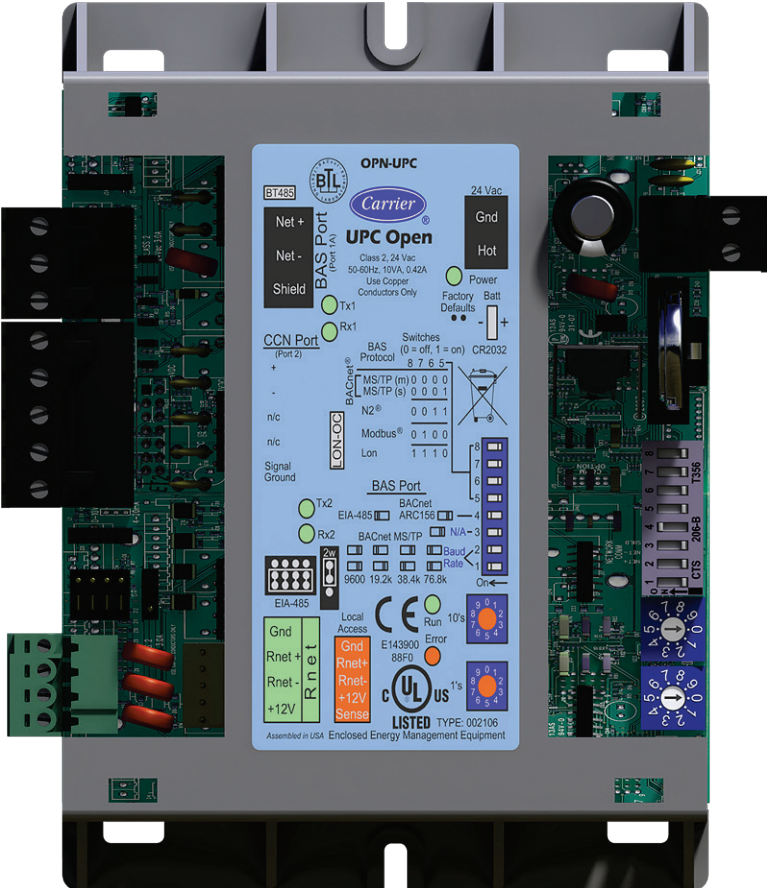

Specifications

Driver	drv_upcopen_x-xxx-xxx
Maximum number of control programs	2
Maximum number of BACnet objects*	1050
* Depends on available memory	Total available memory for application is 551244 bytes. Obtain available memory information by viewing a Module Status report after the control program is loaded.
Power	24 Vac \pm 10%, 50–60 Hz 10 VA power consumption (16 VA with BACview® device attached) 26 Vdc (25 V min, 30 V max) Single Class 2 source only, 100 VA or less We highly recommend using a dedicated transformer to power the UPC Open.
BAS port (Port 1a)	3-pin port supports EIA-485 2-wire communications. Protocols supported (DIP switch selectable): <ul style="list-style-type: none"> ○ BACnet MS/TP (m) ○ BACnet ARC156 ○ Modbus (RTU) (future) ○ Johnson N2 (future) ○ LonWorks (future) This port must be configured as a BAS port.
CCN port (Port 2)	5-pin port supports EIA-485 3-wire connection to a single Carrier CCN controller
LON-OC port	14-pin communication port supports the LonWorks Option Card (future)
Rnet port	The UPC Open only supports ZS sensors, Equipment Touch, and wireless sensors with the 6.04.xxx or later driver. Supports: <ul style="list-style-type: none"> ● Up to 10 ZS sensors (5 per control program) ● One Wireless Adapter that communicates with up to 15 wireless sensors ● One Equipment Touch ● Up to 4 SPT Standard sensors and one SPT Plus, SPT Pro, or SPT Pro-F sensor. NOTE ZS sensors, a Wireless Adapter, and an Equipment Touch can share the Rnet, but not SPT sensors.
Local Access port	For system start-up and controller troubleshooting using Field Assistant or Equipment Touch
Battery	10-year Lithium CR2032 battery retains the following data for a maximum of 10,000 hours during power outages: control programs, editable properties, schedules, and trends.
Protection	Built-in surge and transient protection circuitry - internal solid state Polyswitches on the incoming power and network connections.
Real time clock	Battery-backed real time clock keeps track of time in the event of a power failure

Status indicators	LED's indicate status of communications, running, errors, and power.
Environmental operating range	-22 to 150 °F (-30 to 66 °C), 0 to 90% relative humidity, non-condensing
Storage temperature range	-24 to 140 °F (-30 to 60 °C), 0 to 90% relative humidity, non-condensing
Physical	Rugged GE C2950HF Cyclopol plastic

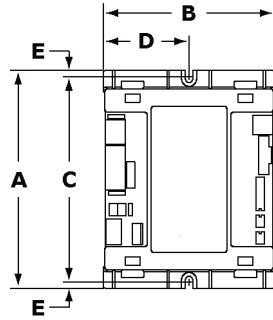

Overall dimensions	A:	5-3/16 in. (13.2 cm)
	B:	4-1/8 in. (10.5 cm)
Mounting hole dimensions	C:	4-7/8 in. (12.4 cm)
	D:	2-1/20 in. (5.2 cm)
	E:	3/16 in. (.5 cm)
Panel depth		2 in. (5.1 cm)
Weight		.44 lbs (.2 kg)
BACnet support		Conforms to the BACnet Advanced Application Controller (B-AAC) Standard Device Profile as defined in ANSI/ASHRAE Standard 135-2012 (BACnet) Annex L, Protocol Revision 9
Listed by		UL-916, (Canadian Std C22.2 No. 205-M1983), CE, FCC Part 15-Subpart B-Class A

Safety considerations

WARNING Disconnect electrical power to the UPC Open before wiring it. Failure to follow this warning could cause electrical shock, personal injury, or damage to the controller.

Installing the UPC Open

- 1 *Mount the controller (page 4).*
- 2 *Wire the controller for power (page 4).*
- 3 *Set the controller's address (page 5).*
- 4 *Wire the controller to the BACnet MS/TP or BACnet ARC156 network (page 5).*
- 5 *Wire the controller to the CCN network (page 5).*
- 6 *Wire devices to the controller's Rnet port (page 8).*

Mounting the UPC Open

WARNING

When you handle the UPC Open:

- Do not contaminate the printed circuit board with fingerprints, moisture, or any foreign material.
- Do not touch components or leads.
- Handle the board by its edges.
- Isolate from high voltage or electrostatic discharge.
- Ensure that you are properly grounded. Screw the UPC Open into an enclosed panel using the mounting slots on the coverplate. Leave about 2 in. (5 cm) on each side of the controller for wiring. Mounting hole dimensions 4.8 in. (12.2 cm) between mounting slot center lines.

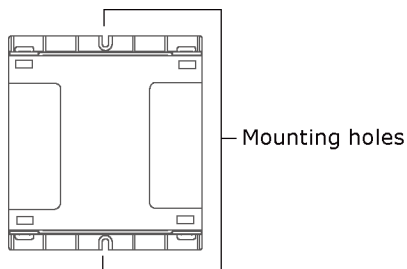

Wiring the UPC Open for power

 **CAUTION** The UPC Open is powered by a Class 2 power source. Take appropriate isolation measures when mounting it in a control panel where non-Class 2 circuits are present. The UPC Open is a half wave device. Half wave and full wave devices **cannot** share power. Examples of a full wave device are a CVC or ICVC in an applied chiller.

Carrier controllers can share a power supply as long as you:

- Maintain the same polarity
- Use the power supply only for Carrier Open controllers

To wire for power

- 1 Remove power from the power supply.
- 2 Pull the screw terminal connector from the controller's power terminals labeled **Gnd** and **Hot**.
- 3 Connect the transformer wires to the screw terminal connector.

NOTE If using a grounded transformer, connect the ungrounded lead to the **Hot** terminal to avoid damaging the transformer.
- 4 Apply power to the power supply.
- 5 Measure the voltage at the UPC Open's power input terminals to verify that the voltage is within the operating range of 21.6–26.4 Vac.
- 6 Insert the screw terminal connector into the UPC Open's power terminals.
- 7 Verify that the **Power** LED is on and the **Run** LED is blinking.

Addressing the UPC Open

EIA You must give the UPC Open a MAC address that is unique on the MS/TP or ARCNET network. You can address the UPC Open before or after you wire it for power.

- 1 If the UPC Open has been wired for power, pull the screw terminal connector from the controller's power terminals labeled **Gnd** and **Hot**. The controller reads the address each time you apply power to it.
- 2 Using the rotary switches, set the controller's address. Set the **Tens (10's)** switch to the tens digit of the address, and set the **Ones (1's)** switch to the ones digit.

EXAMPLE If the controller's address is 25, point the arrow on the **Tens (10's)** switch to 2 and the arrow on the **Ones (1's)** switch to 5.

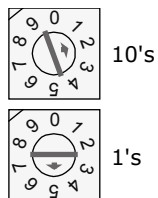

CAUTION The factory default setting is **00** and must be changed to successfully install your UPC Open.

Wiring for communications

The UPC Open communicates using BACnet on the following types of network segments:

- MS/TP communicating at 9600 bps, 19.2 kbps, 38.4 kbps, or 76.8 kbps
- ARC156 communicating at 156 kbps

NOTE For more networking details, see the *Open Controller Network Wiring Installation Guide*.

Wiring specifications for BACnet MS/TP and ARC156

Cable:	22 AWG or 24 AWG, low-capacitance, twisted, stranded, shielded copper wire
Maximum length:	2000 feet (610 meters)



WARNING Do not apply line voltage (mains voltage) to the controller's ports and terminals.

To wire the controller to the BACnet network

- 1 Pull the screw terminal connector from the controller's power terminals labeled **Gnd** and **Hot**.
- 2 Check the communications wiring for shorts and grounds.
- 3 Connect the communications wiring to the controller's screw terminals labeled **Net +**, **Net -**, and **Shield**.
NOTE Use the same polarity throughout the network segment.
- 4 Set the communication type and baud rate.

For...	Set DIP switches 1 and 2 to...	DIP switch 3	Set DIP switch 4 to...	Set DIP switches 5 through 8 to...
MS/TP (m)	The appropriate baud rate. See the MS/TP Baud diagram on the controller.	N/A	On	Off/Off/Off/Off
ARC156	N/A. Baud rate will be 156 kbps regardless of the DIP switch settings.	N/A	Off	N/A

NOTE Use the same baud rate for all controllers on the network segment.

- 5 For MS/TP, verify that the EIA-485 jumpers are set to EIA-485 and 2w.
- 6 Wire the controllers on a BACnet MS/TP or BACnet ARC156 network segment in a daisy-chain configuration.
- 7 If the UPC Open is at either end of a network segment, connect a BT485 to the UPC Open.
- 8 Insert the power screw terminal connector into the UPC Open's power terminals.
- 9 Verify communication with the network by viewing a Module Status report in the i-Vu® interface.

Wiring the UPC Open to the CCN network

The UPC Open's CCN Port communicates using EIA RS-485 and supports 9600 bps. Future versions will support baud rates of 19.2 and 38.4 kbps.

NOTES

- The UPC Open is intended to be wired directly to one piece of Carrier equipment.
 - NOTE** The exception is a Multiple Chiller application, which consists of 2 or 3 chillers configured for Lead/Lag, with a potential third chiller as a standby chiller. In this application, wire the CCN network between the UPC Open and chillers in a daisy-chain configuration. All other applications have one network segment between the UPC Open and the interfaced Carrier equipment.
- Refer to the *CCN Installation and Start-up Guide* for more details on wiring the CCN bus.

Multiple chiller application only (Lead/Lag, and, possibly, a standby chiller)

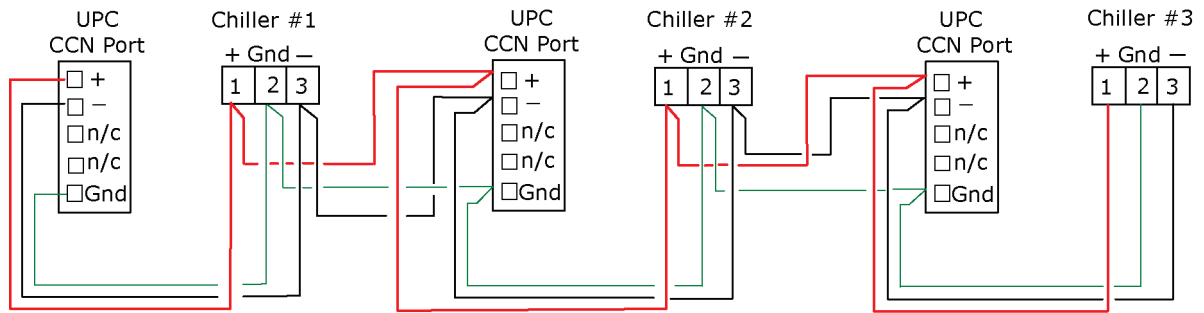

Single unit application

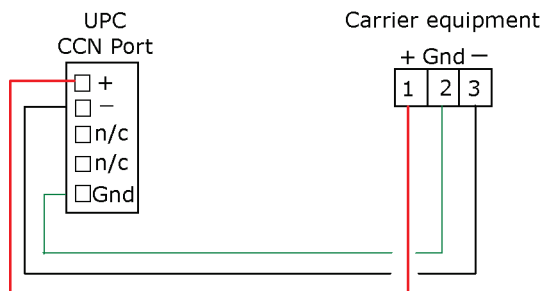

Wiring specifications for CCN

Cable:	20 AWG, general purpose, 3-conductor, foil shielded copper wire
Maximum length:	1000 feet (305 meters)

To wire the CCN equipment to the UPC Open

- 1 Pull the screw terminal connector from the controller's power terminals labeled **Gnd** and **Hot**.
- 2 Pull the screw terminal connector from the UPC Open's **CCN Port**.
- 3 Check the communications wiring for shorts and grounds.
- 4 Connect the communications wiring to the CCN Port's screw terminals labeled **Net +**, **Net -**, and **Shield**.
NOTE Maintain the same polarity.
- 5 Verify that the EIA-485 jumpers are set to EIA-485 and 2w.
- 6 Insert the power screw terminal connector into the UPC Open's CCN Port's terminals.
- 7 Insert the power screw terminal connector into the UPC Open's power terminals.
- 8 Verify the LED lights **TX2** and **RX2** are flashing to indicate the UPC Open is communicating on the CCN Port.
NOTE If the CCN target address differs from what the UPC Open is configured for (default 0, 1), then only the transmit LED flashes about 1 time per second.

Wiring devices to the UPC Open's Rnet port

The UPC Open only supports ZS sensors, Equipment Touch, and wireless sensors using the 6.04.xxx or later driver.

You can connect communicating zone sensors and/or the Equipment Touch with built-in temperature and humidity sensors to monitor room temperature.

The Rnet communicates at a rate of 115 kbps.

CAUTIONS

- You **cannot** have an SPT sensor on the same Rnet as a ZS sensor or an Equipment Touch.
- Do not exceed 200 mA for all Rnet devices.

NOTE The ZS CO2 model uses 190 mA during sample period. Use auxiliary 12 Vdc if needed.

Rnet wiring specifications

NOTE Use the specified type of wire and cable for maximum signal integrity.

Description	4 conductor, shielded or unshielded, CMP, plenum rated cable
Conductor	22 AWG (7x0096) bare copper if Rnet has only sensors
Maximum length	500 feet (152 meters)
Insulation	Low-smoke PVC (or equivalent)

Color Code	Black, white, green, red
Shielding	If shielded, Aluminum/Mylar shield (100% coverage) with TC drain wire, terminated at controller
UL temperature rating	32–167 °F (0–75 °C)
Voltage	300 Vac, power limited
Listing	UL: NEC CL2P, or better

ZS Sensor overview

ZS Sensors are thermistor-based temperature sensors that may optionally sense humidity, CO₂, or VOC. ZS Sensors are wired to the Rnet port on i-Vu® Open controllers.

REQUIREMENTS

- A v6.5 or later i-Vu® system
- v6.04.xxx or later controller drivers

You can use the following ZS sensors:

- ZS Standard
- ZS Plus
- ZS Pro

NOTES

- A control program can use no more than 5 ZS Sensors, so you must use 2 control programs if your Rnet network has 10 sensors.
- The ZS CO₂ model uses 190 mA during sample period. Use auxiliary 12 Vdc, unless it is the only device on the Rnet port.

For basic user instructions, see the *ZS Sensor User Guide*. For detailed installation instructions, see the *ZS Sensors Installation Guide*.

SPT sensor overview

The UPC Open is connected to a wall-mounted space temperature sensor to monitor room temperature. Wire SPT sensors to the UPC Open's **Rnet** port.

The UPC Open supports the following:

- SPT Standard
- SPT Plus
- SPT Pro

For basic user instructions, see the *SPT Sensors Owner Guide*. For more detailed instructions, see the *Carrier Sensors Installation Guide*.

NOTE If the Rnet has multiple SPT Standard sensors, you must give each a unique address on the Rnet.

To wire the ZS or SPT sensor to the UPC Open

- 1 Partially cut, then bend and pull off the outer jacket of the Rnet cable(s). Do not nick the inner insulation. Strip about .25 inch (.6 cm) of the inner insulation from each wire.

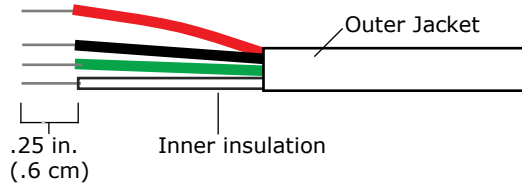

- 2 Wire each terminal on the sensor to the same terminal on the controller. See diagram below.

NOTE Carrier recommends that you use the following Rnet wiring scheme:

Connect this wire...	To this terminal...
Red	+12V
Black	Rnet-
White	Rnet+
Green	Gnd

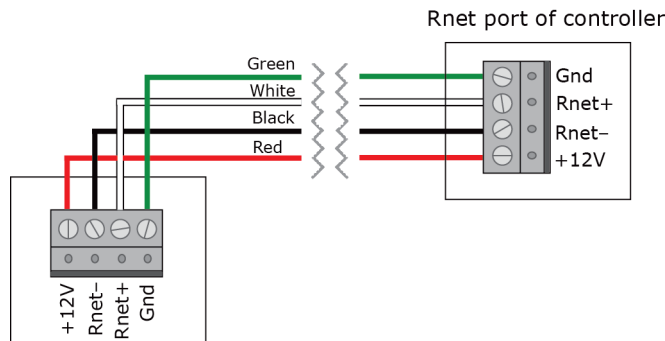

Wireless sensor overview

The Carrier wireless sensors, designed for zone control, are low-power wireless devices that use light-harvesting through solar panels as their primary power source. The wireless line of sensors includes the models shown in the list below. All are available in 868, 902, and 928 MHz radio frequency. The sensors are thermistor-based temperature sensors that may optionally sense humidity

Wireless sensors communicate through a Wireless Adapter, which is wired to the Rnet port of the controller.

REQUIREMENTS

- A v6.5 or later i-Vu® system
- v6.04-xxx or later controller drivers

The following is a list of wireless supported devices:

- Standard
- Plus
- Adapter
- Motion/Lux Sensor
- Window/Door Sensor

To configure the control program for the desired user interaction with the sensor, see the *Wireless Sensors Application Guide*. For detailed instructions, see the *Wireless Sensors Installation Guide*.

To install the Wireless Adapter for wireless sensors



WARNING Do not apply line voltage (mains voltage) to the Wireless Adapter.

To wire, power, and mount the Wireless Adapter

NOTES

- The Wireless Adapter requires a 24 Vac or 24 Vdc power supply. It is not powered by the Rnet.
- If the Wireless Adapter will be:
 - Daisy-chained on the Rnet with ZS sensors or an Equipment Touch, use the standard 4-conductor Rnet wiring.
 - The only device on the Rnet, you can use a 3-conductor cable instead of the standard 4-conductor Rnet cable.

- 1 Turn off the power to the controller that the Wireless Adapter will be wired to.
- 2 Partially cut, then bend and pull off the outer jacket of the Rnet cable(s). Do not nick the inner insulation.

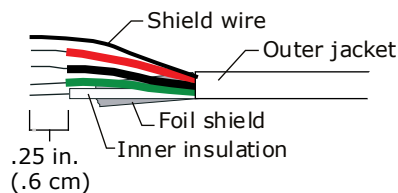

- 3 Strip about .25 inch (.6 cm) of the inner insulation from each wire.

- 4 Wire the **Rnet +**, **Rnet -**, and **Gnd** terminals on the controller's **Rnet** port to the terminals of the same name on the Wireless Adapter's Rnet connector.

NOTE If using shielded wire, connect the shield wire and the ground wire to the **Gnd** terminal.

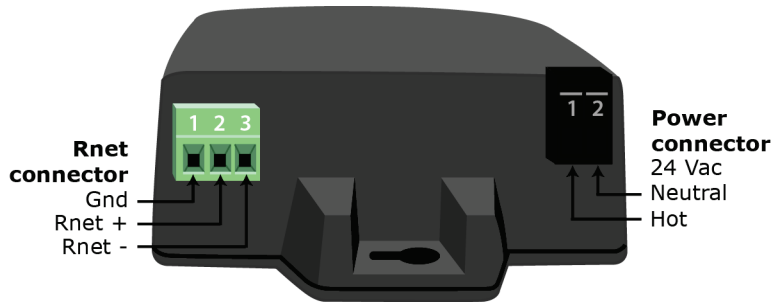

- 5 Wire the 24 Vac external power supply to the Wireless Adapter's power connector.
- 6 Mount the Wireless Adapter by inserting 2 screws through the mounting tabs on each end of the Wireless Adapter.
- 7 Apply power to the external power supply.
- 8 Verify that the LED on top of the Wireless Adapter is blinking. See "LED" below.
- 9 Turn on the controller's power.

LED

The blue LED on the top of the Wireless Adapter indicates the following:

If the LED is...	Then the device...
Off	Is not powered or there is a problem.
Blinking	Is working properly.
Steadily on	Has a problem. Do one of the following: <ul style="list-style-type: none"> • Cycle power to the device. • Insert a small screwdriver or paper clip into the hole next to the LED to reboot the device.

To wire an Equipment Touch to the UPC Open

NOTE The Equipment Touch requires a 24 Vac power supply. It is not powered by the Rnet.



CAUTION Carrier controllers can share a power supply as long as you:

- Maintain the same polarity.
- Use the power supply only for Carrier controllers.

If the Equipment Touch will be:

- Daisy-chained on the Rnet with ZS sensors or a Wireless Adapter, use the standard 4-conductor Rnet wiring and follow the wiring instructions *To wire a ZS or SPT sensor to the UPC Open* (page 10).
- The only device on the Rnet, you can use a 2-conductor cable instead of the standard 4-conductor Rnet cable and follow the instructions below.

For complete Equipment Touch installation instructions including wiring diagrams, see the *Equipment Touch Installation and Setup Guide*.

- 1 Turn **off** the UPC Open's power.
- 2 Partially cut, then bend and pull off the outer jacket of the cable. Do not nick the inner insulation.

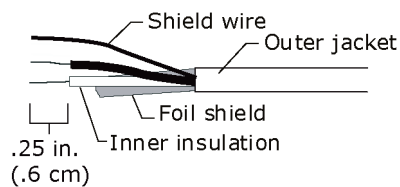

- 3 Strip about .25 inch (.6 cm) of the inner insulation from each wire.
- 4 Wire the UPC Open's **Rnet+** and **Rnet-** terminals to the terminals of the same name on the Equipment Touch's connector.

NOTE If using shielded wire, connect the shield wire and the ground wire to the **Gnd** terminal.

- 5 Turn **on** the UPC Open's power.
- 6 Turn on the Equipment Touch.

Start-up

Use one of the following interfaces to start up, access information, read sensor values, and test the controller.

This interface...	Provides a...
Field Assistant application - Runs on a laptop that connects to controller's Local Access port ¹	Temporary interface
Equipment Touch device - Connects to controller's Rnet port ²	Temporary or permanent interface
I-Vu® application Available for BACnet systems only	Permanent interface
System Touch device Available only for BACnet MS/TP systems. Wire to a BACnet MS/TP network connector and a 24 Vac power supply ³	Temporary or permanent interface

¹ Requires a USB Link (Part #USB-L).

² See the *Equipment Touch Installation and Setup Guide* for detailed instructions.

³ See the *System Touch Installation and Setup Guide* for detailed instructions.



CAUTION If multiple controllers share power but polarity was not maintained when they were wired, the difference between the controller's ground and the computer's AC power ground could damage the USB Link and the controller. If you are not sure of the wiring polarity, use a USB isolator between the computer and the USB Link. Purchase a USB isolator online from a third-party manufacturer.

Select or create a custom control program and graphic for the UPC Open

The field-installed UPC Open does not come from the factory with a control program or graphic. You must load a control program and graphic as part of the installation/commissioning of the UPC Open. You can select a control program and graphic from EquipmentBuilder that has all the configurations that are currently available on a factory-installed UPC Open. You can also create a custom control program using Snap. See Snap Help for details.

NOTES

- You MUST have installed the February 2017 or later cumulative update and the 6.04.xxx or later driver to be able to create custom control programs, .view files, or .touch files for the ZS sensors, wireless sensors, or touchscreen.
- Third party mapping information for current Carrier PIC products, whether on a factory-installed UPC Open or selected from EquipmentBuilder, can be found on the *Carrier Control Systems Support Site* <http://www.hvacpartners.com/> under **Support Center > Controls Support > Controls Product Information**.

Consider the following before creating your program in Snap:

- Is the equipment already available in EquipmentBuilder?
- Which points from the Carrier equipment are to be mapped in the UPC Open?
- What type of Carrier microblock does each point require?
- Do you need to create custom **Property** pages for the equipment?
- Are there any special microblocks you may need, such as **Communication Device, Schedule, Alarms**?

To create your control program in Snap, you must:

- Obtain your CCN points list from the equipment or CCN database.
- Know what points need to be mapped in the control program to the equipment.
- Load a separate control program if Airside Linkage is needed and the UPC Open is used on a rooftop unit. An Airside Linkage equipment file can be selected in EquipmentBuilder.

After creating your control program, you can create a custom graphic using ViewBuilder. See *To install the UPC Open into an i-Vu® Control System* (page 15) to load your control program and graphic into the controller.

To install the UPC Open into an i-Vu® Control System

You must complete the following procedures to successfully install your UPC Open into an i-Vu® Control System. Use the Help in the referenced software for detailed descriptions of these procedures.

EquipmentBuilder or Snap

- 1 Use EquipmentBuilder or Snap to create control program(s) for your UPC Open.
- 2 If applicable, print the Sequence of Operation, which includes the points list.

NOTE You can create a points list under **Reports** in the i-Vu® application or Field Assistant after installing your control program.

The i-Vu® or Field Assistant application

- 1 Upload the controller to the database by selecting the router in the navigation tree.
- 2 Select **Devices > Manage** tab.
- 3 Select the controller in the list on the page.
- 4 If you are adding a new control program, click **Add Control Program**. A dialog window appears.
- 5 Enter a name for your control program in **Display Name** and select your controller in the **Controller** drop-down list.

NOTES

- If you already have the maximum number of control programs for a controller, it will not appear in the list.
- Optional: You can change the control program's **Reference Name** if needed.

- 6 Do one of the following:

If the control program is...

In the Control Program drop-down list	Select the control program.
Not in the Control Program drop-down list	<ul style="list-style-type: none"> a. Click Add New. b. Browse to select the control program. c. Click Open. d. Click Continue. e. Click Close.

- 7 To upload a graphic, click **Add New** under **Views** and browse to your .view file.
- 8 Click **Continue**. When message appears **File added successfully**, click **Close**.
- 9 Click **Close** again.
- 10 Right-click on the programmable controller in the controller list and select **Check Status** from the list. The status of the controller should say **File Mismatch**.
- 11 Click the **Download All Content** button.
- 12 Assign channel numbers to the physical points by selecting the controller in the navigation tree and going to **Properties** page > **I/O Points** tab.
- o Enter your channel numbers under **Num**, using your wire list.
 - o Enter your expander address under **Exp**, if applicable.
 - o Select the appropriate value under **Sensor/Actuator Type**, if applicable.
- 13 Configure the controller on the **Properties** page > **Control Program** tab.
- 14 Check out and commission the equipment.

Configure the UPC Open's properties

To start up the UPC Open, set the following properties:

Navigation: i-Vu® / Field Assistant: **Properties > Control Program > Status**
 BACview®: **CCN**

Point Name/Description	Default/Range
<p>Element Comm Stat - The UPC Open's current status of communication to the CCN equipment. Click the Element Comm Stat microblock link to change the CCN equipment target address - bus and element number.</p> <p>NOTE If more than one UPC Open is connected to a CCN bus for a Multiple Chiller Application, you must change the CCN controller's address in this object's Summary tab.</p>	<p>D: 0, 1</p> <p>R: Bus: 0.1 - 239</p> <p>Element: 1 - 239</p>

Navigation: i-Vu® / Field Assistant:

Driver Properties > Communications > CCN

Point Name/Description	Default/Range
CCN Address - Configuration of the UPC Open's CCN element number.	D: 0, 200 R: 1 - 239

NOTES

If the UPC Open is used in a Multiple Chiller Application, then you must change the address of the chillers and the CCN address of all the UPC Open controllers to ensure they are all unique. In this application, the maximum number of UPC Open controllers allowed on the CCN bus is **3**.

- **CCN Alarm Acknowledger** – The UPC Open defaults as the **CCN Acknowledger**. In a Multiple Chiller Application, you must configure only one of the UPC Open controllers as the **CCN Acknowledger**.
- **CCN Time Broadcaster** – The UPC Open can be a **CCN Time Broadcaster**. In a Multiple Chiller Application, you must configure only one of the UPC Open controllers as the **CCN Time Broadcaster**.
- In chiller applications, verify the chiller is configured in CCN mode. If the chiller is not in CCN mode, then the UPC Open is not able to force points or write to the chiller. Refer to the specific chiller's documentation for information on how to setup the chiller to be in CCN mode.

Troubleshooting

If you have problems mounting, wiring, or addressing the UPC Open, contact Carrier Control Systems Support.

NOTE To help you troubleshoot, obtain a Module Status (Modstat) from the controller and review the System Error and Warning details.

LED's

The LED's indicate if the controller is speaking to the devices on the network. The LED's should reflect communication traffic based on the baud rate set. The higher the baud rate the more solid the LED's become.

Verify the LED patterns by cycling power to the controller and noting the lights and flashes.

LEDs	Status
Power	Lights when power is being supplied to the controller. NOTE The UPC Open is protected by internal solid state Polyswitches on the incoming power and network connections. These Polyswitches are not replaceable, but they will reset themselves if the condition that caused the fault returns to normal.
Rx	Lights when the controller receives data from the network segment; there is an Rx LED for Ports 1 and 2.
Tx	Lights when the controller transmits data from the network segment; there is an Rx LED for Ports 1 and 2.
Run	Lights based on controller health.
Error	Lights based on controller health.

The **Run** and **Error** LED's indicate controller and network status.

If Run LED shows...	And Error LED shows...	Status Is...
1 flash per second	1 flash per second, alternating with the Run LED	The controller files are archiving. Archive is complete when Error LED stops flashing.
2 flashes per second	Off	Normal
2 flashes per second	2 flashes, alternating with Run LED	Five minute auto-restart delay after system error
2 flashes per second	3 flashes, then off	The controller has just been formatted
2 flashes per second	4 flashes, then pause	Two or more devices on this network have the same network address
2 flashes per second	1 flash per second	The controller is alone on the network

If Run LED shows...	And Error LED shows...	Status Is...
2 flashes per second	On	Exec halted after frequent system errors, due to: <ul style="list-style-type: none"> • Controller halted • Program memory corrupted • One or more programs stopped
5 flashes per second	On	Exec start-up aborted, Boot is running
5 flashes per second	Off	Firmware transfer in progress, Boot is running
7 flashes per second	7 flashes per second, alternating with Run LED	Ten second recovery period after brownout
14 flashes per second	14 flashes per second, alternating with Run LED	Brownout
On	On	Failure. Try the following solutions: <ul style="list-style-type: none"> • Turn the UPC Open off, then on. • Download memory to the UPC Open. • Replace the UPC Open.

NOTE If you resolve the issue but the **Error** LED does not turn off, cycle power to the controller.

To get the serial number

If you need the UPC Open's serial number when troubleshooting, the number is on:

- a sticker on the back of the main controller board
- a Module Status report (Modstat) under **Core** (or **Main**) **board hardware**

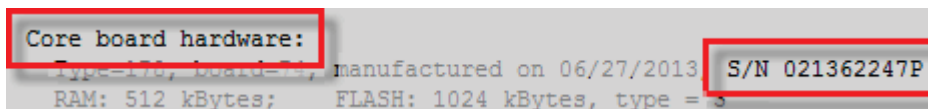

To obtain a modstat in the i-Vu® interface:

- 1 Select the UPC Open in the navigation tree.
- 2 Right-click and select **Module Status**.

To restore defaults

 **CAUTION** This erases all archived information and user-configuration settings. You will have to reconfigure all custom settings. It is recommended to restore the factory defaults only under the guidance of Carrier Control Systems Support.

To erase volatile memory data and restore factory default configuration settings:

- 1 Turn off the UPC Open's power switch.
- 2 Put the **Factory Defaults** jumper on.
- 3 Turn on the UPC Open's power switch.
- 4 Remove the **Factory Defaults** jumper.

To replace the UPC Open's battery

To determine when to replace the battery, remove power and measure the voltage. If the voltage is below 2.9 volts, you need to replace the battery.

 **CAUTION** Power must be **ON** to the UPC Open when replacing the battery, or your date, time, and trend data will be lost.

- 1 Remove the battery from the controller, making note of the battery's polarity.
- 2 Insert the new battery, matching the battery's polarity with the polarity indicated on the UPC Open.

Compliance

FCC Compliance

This equipment has been tested and found to comply with the limits for a Class A digital device, pursuant to Part 15 of the FCC Rules. These limits are designed to provide reasonable protection against harmful interference when the equipment is operated in a commercial environment. This equipment generates, uses, and can radiate radio frequency energy and, if not installed and used in accordance with the instruction manual, may cause harmful interference to radio communications. Operation of this equipment in a residential area is likely to cause harmful interference in which case the user will be required to correct the interference at his own expense.



CAUTION Changes or modifications not expressly approved by the responsible party for compliance could void the user's authority to operate the equipment.

CE Compliance



WARNING This is a Class A product. In a domestic environment, this product may cause radio interference in which case the user may be required to take adequate measures.

BACnet Compliance

Compliance of listed products to requirements of ASHRAE Standard 135 is the responsibility of BACnet International. BTL® is a registered trademark of BACnet International.

Appendix: Single Point Linkage and Device Address Binding

Single Point Linkage

The UPC Open receives data from other Open controllers when they are installed as part of an i-Vu® Control System. The data transfer may take the form of Single Point Linkage (SPL), which is automatic, or Device Address Binding, which you must configure.

Currently, the UPC Open implements Single Point Linkage (SPL) for 3 variables:

- **System Cool Demand Level**
- **System Heat Demand Level**
- **System Outside Air Temperature**

Network Points for which SPL has been implemented are displayed in Field Assistant and the i-Vu® interface on the **Properties** page > **Network Points** tab.

The following example involves outside air temperature. **System Heat & Cool Demand Level** behaves similarly, except that their usage involves a specific application loaded on a Universal Controller Open. See *UC Open Installation Guide* for additional information. In either case, note that the BACnet type and instance numbers specified in the **Address** field of these variables have been predefined.

Network variables for which SPL is used are easily identified on the **Properties** page > **Network Points** tab. The asterisk in the BACnet address invokes the SPL function. These addresses cause the controller to issue a BACnet “who has” command for this variable. The controller binds to the closest of the first 5 devices from which it receives a valid response.

Name	Type	Value	Locked	Default Value	Com Enabled	COV Enable	Refresh Time (mm:ss)	Address	Error
System Cool Demand Level	{ANI}	3.00	<input type="checkbox"/>	0	<input checked="" type="checkbox"/>		1:00	bacnet://AV:80004	0 No Error, bound to DEV:1610907, AV:80004
System Heat Demand Level (Primary) (Secondary)	{ANI2}	0.00	<input type="checkbox"/>	0	<input checked="" type="checkbox"/>		1:00	bacnet://AV:80005 bacnet://AV:80005	7 Binding in progress 7 Binding in progress

Address containing * (asterisk) denotes Single Point Linkage

Predefined Type and Instance Number

Indicates successful binding

Device Address Binding

As described previously, **Device Address Binding** allows the UPC Open to receive data from other Open controllers when they are connected by a network. You must configure this method.

Currently, the UPC Open allows **Device Address Binding** (DAB) only for **System Space Temperature**.

You can implement DAB on network points with an undefined BACnet address, displayed in Field Assistant and the i-Vu® interface on the **Properties** page > **Network Points** tab. See example below.

Name	Type	Value	Locked	Default Value	Com Enabled	COV Enable	Refresh Time (mm:ss)	Address	Error	Present Value
System Space Temperature (Primary)	(AN)2	-999.00	<input type="checkbox"/> 0	-999	<input checked="" type="checkbox"/>		1:00	Search / Replace bacnet://	0 No Error	-999
(Secondary)								bacnet://	0 No Error	-999

Undefined BACnet Address

Currently "Unbound"

Document revision history

Important changes to this document are listed below. Minor changes such as typographical or formatting errors are not listed.

Date	Topic	Change description	Code*
6/1/17	ZS Sensor overview Wireless sensor overview	Changed driver to 6.04-xxx	C-TS-RD-E
5/19/17	Select or create a custom control program and graphic for the UPC Open	Custom control programs and graphics for ZS sensors, wireless sensors, or touchscreen, require the February 2017 or later cumulative update.	C-TS-RD-E
	Specifications Wiring devices to the UPC Open's Rnet port	The following note added: The UPC Open only supports ZS sensors, Equipment Touch, and wireless sensors using the 6.04.xxx or later driver.	C-TS-RD-E
4/7/17	Wireless sensor overview To install the Wireless Adapter for Wireless sensors To wire an Equipment Touch to the UPC Open	New topics	C-D
	Wiring devices to the UPC Open's Rnet port	Added Wireless Adapter for wireless sensors and Equipment Touch	C-D
	To wire the controller to the BACnet network	Added BACnet ARC156 connection information	C-D
	Wiring for communications	Changed from Wiring the UPC Open to the MS/TP network	C-D
	Safety Considerations	Warning added to disconnect controller before wiring.	C-D
	Specifications	Added ARC156, Equipment Touch, ZS, and Wireless Adapter for Wireless sensor capability.	C-D
	Cover What is the UPC Open?	Changed to latest controller image.	C-D
		All references to BACview removed	C-D
2/22/16	Local access to the UPC Open	Added USB Link wiring caution.	C-TS-RD-E-JH
1/12/16	What is the UPC Open?	Corrected Universal Protocol Card to Unitary Protocol Converter	C-TS-RD-E
	UPC Open specifications	Changed Maximum number of BACnet objects to Unlimited from 1050	C-TS-RD-O
	Restore factory defaults	Added information on using the Factory Defaults jumper	C-D-LJ-RD-E

* For internal use only



CARRIER CORPORATION ©2017

A member of the United Technologies Corporation family · Stock symbol UTX · Catalog No. 11-808-468-01 · 6/1/2017