

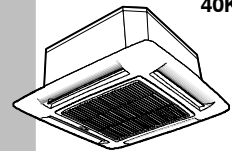

33MC-URC Room Controller

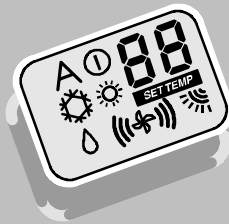

40KMC
40KMQ

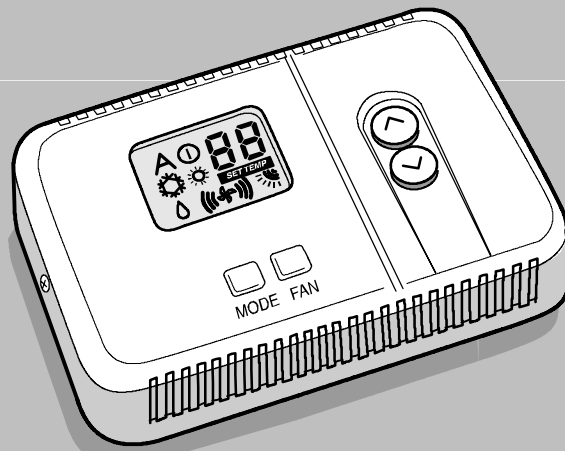
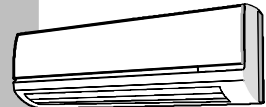

40QNC
40QNQ

This control system only operates with indoor units of the following types:
40KMC, 40KMQ Cassette, 40QNC, 40QNQ High Wall

For installation instructions of this unit, refer to the relevant manuals.

CONTENTS

PAGE

General information	2
Characteristics	2
Choosing the installation site	2
“Room Controller” wired control	3
Electrical connections to indoor unit	4
Unit configuration	4, 6
Troubleshooting	6

INSTALLATION FLOW CHART

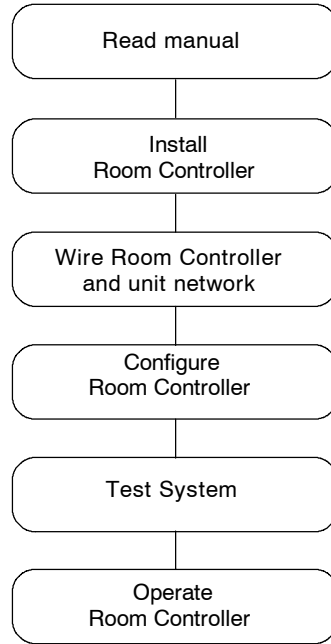

33MC--URC

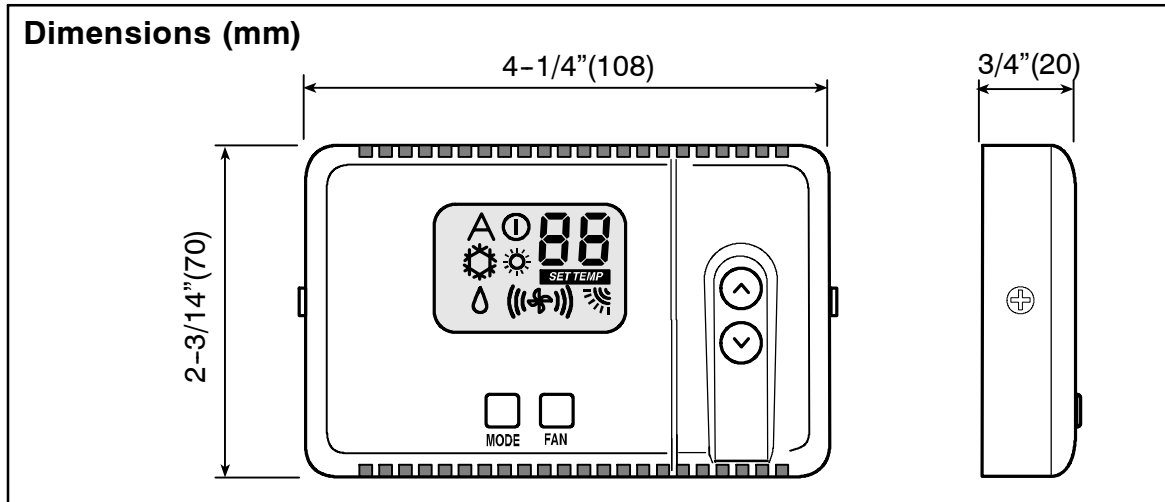

SAFETY CONSIDERATIONS

Improper installation, adjustment, alteration, service, maintenance, or use can cause explosion, fire, electrical shock, or other conditions which may cause death, personal injury, or property damage. Consult a qualified installer, service agency, or your distributor or branch for information or assistance. The qualified installer or agency must use factory-authorized kits or accessories when modifying this product. Refer to the individual instructions packaged with the kits or accessories when installing.

Follow all safety codes. Wear safety glasses, protective clothing, and work gloves. Use quenching cloth for brazing operations. Have fire extinguisher available. Read these instructions thoroughly and follow all warnings or cautions included in

literature and attached to the unit. Consult local building codes and National Electrical Code (NEC) for special requirements.

Recognize safety information. This is the safety-alert symbol . When you see this symbol on the unit and in instructions or manuals, be alert to the potential for personal injury. Understand these signal words; DANGER, WARNING, and CAUTION. These words are used with the safety-alert symbol. DANGER identifies the most serious hazards which **will** result in severe personal injury or death. WARNING signifies hazards which **could** result in personal injury or death. CAUTION is used to identify unsafe practices which **would** result in minor personal injury or product and property damage. NOTE is used to highlight suggestions which **will** result in enhanced installation, reliability, or operation.

General information and characteristics

IMPORTANT: Read the entire instruction manual before starting the installation.

- For trouble-free installation, which should be carried out by a qualified installer, follow the installation chart sequence.
- Follow all current national safety code requirements. In particular ensure that a properly sized and connected ground wire is in place.
- After installation, thoroughly test the system operation and explain all system functions to the owner.
- Leave this manual with the owner for consultation during future periodic maintenance.
- Dispose of packaging material in accordance with local requirements.
- The manufacturer denies any responsibility and warranty shall be void if these installation instructions are not observed.
- Inspect equipment. For damage due to improper transportation or handling, file an immediate claim with the shipping company. **Do not** install or use damaged units.
- In case of any malfunction, turn the unit off, disconnect the main power supply and contact a qualified service engineer.

WIRING

The Room Controller will be capable of controlling from 1 to 6 Fan Coil Units.

The total run length of the wire connecting the Room Controller to the FCUs should be kept to under 500 feet (150 m.).

Only daisy chain wiring will be allowed (See Figure 1).

Choosing the installation site and Installation

Room Controller Location

The Room Controller can be located anywhere. However, if the installation requires the system in the location to use the air sensor on the Room Controller; then, the controller should be mounted:

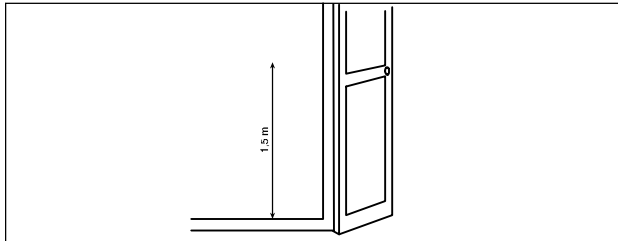

- Approximately 5 ft. (1.5 m) from floor.

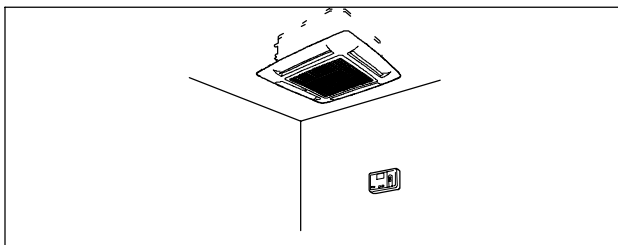

Fig. 10 – Minimum Clearances

The Room Controller will connect to the receiver board connection on the electronic board inside the unit.

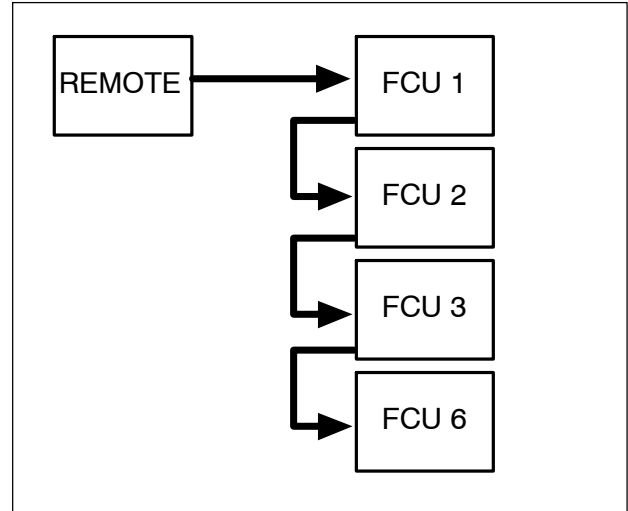

Fig. 9 – Daisy Chain Wiring (Multidrop)

POWER

The thermostat will be powered by unregulated 12.5 volts DC nominal (10V min. to 20V max) which is provided by the electronic board inside the unit.

The power consumption will be 50mA 12.5 volts DC.

For applications where more than one FCU is to be controlled, the FCU closest to the Room Controller will be the only one that supplies power to the Room Controller.

The control should be protected from damage if accidental miswiring of power, ground and signal.

- In the same area where the unit is located, preferably on an inside partitioning wall.
- On a section of wall without pipes or duct work.

If the air sensor on the Room Controller has been selected, it should **NOT** be mounted:

- Close to a window, on an outside wall, or next to a door leading to the outside.
- Exposed to direct light and heat from a lamp, sun, fireplace, or other temperature-radiating object which may cause a false reading.

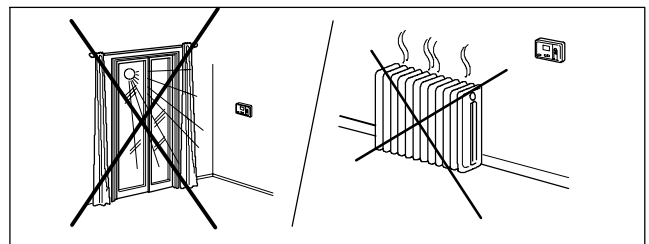

- Close to or in direct airflow of a heating or cooling supply.
- In areas with poor air circulation, such as behind a door or in an alcove.

Maximum of 500 ft. (150 m) of total network wiring.

General information and characteristics

MOUNTING

⚠ WARNING

ELECTRICAL SHOCK HAZARD

Failure to follow this warning could result in personal injury or death.

Before installing the Room Controller, turn off all power to the Unit that will supply power to the Room Controller.

- Turn OFF all power to unit.

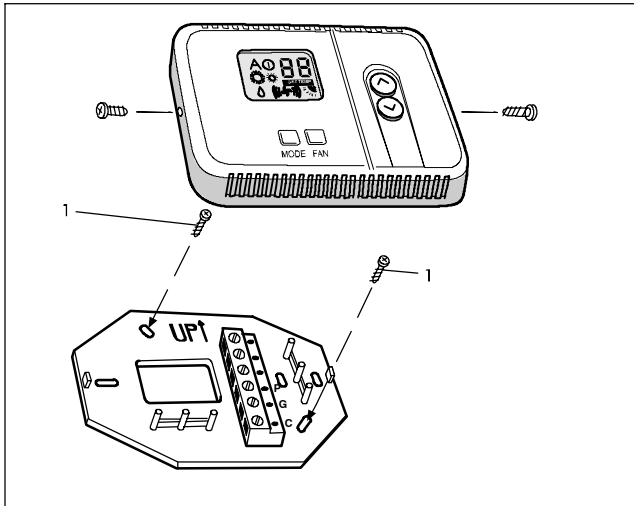

Fig. 11 – Mounting Screws

- Unscrew the side fixing screw.
- Open the Room Controller rear mounting base to expose mounting holes. The base can be removed to simplify mounting (snap apart carefully at hinge to separate mounting base from remainder of the Room Controller).
- Route the Room Controller wires through the large hole in the mounting base. Level mounting base against wall (for aesthetic value only the Room Controller need not be level for proper operation) and mark the wall through the 2 mounting holes.
- Drill two 3/16" (5 mm) mounting holes in wall where marked.
- Secure mounting base correctly (UP↑) to wall with 2 screws and anchors provided, (additional anchoring holes available for more secure mounting if needed) making sure all wires extend through hole in mounting base.
- Adjust length and routing of each wire to reach the proper terminal in the connector block on the mounting base, with 1/4" (6 mm) of extra wire (strip only 1/4" (6 mm) of insulation from each wire to prevent adjacent wires from shorting together when connected).

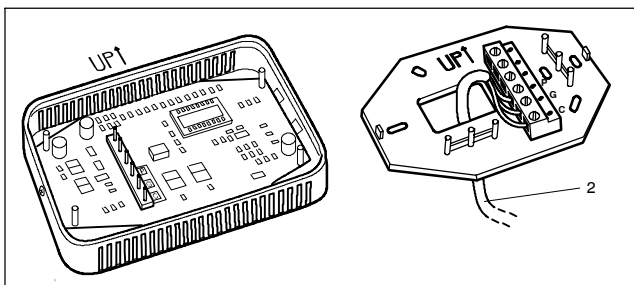

Fig. 12 – Connection Cable

- Match and connect equipment wires to proper terminals in the connector block. Both power and communication wires must be connected correctly for proper Room Controller operation.

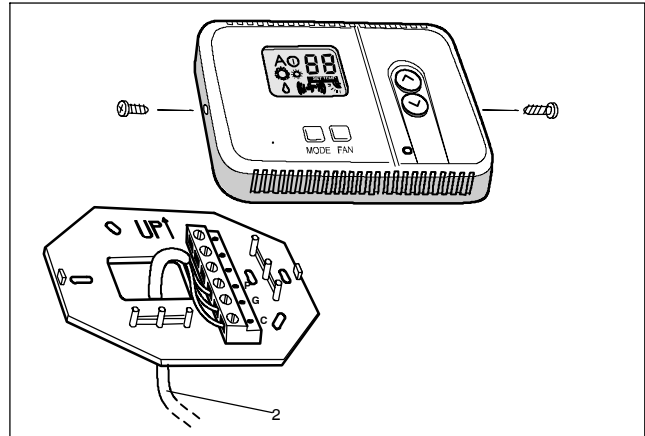
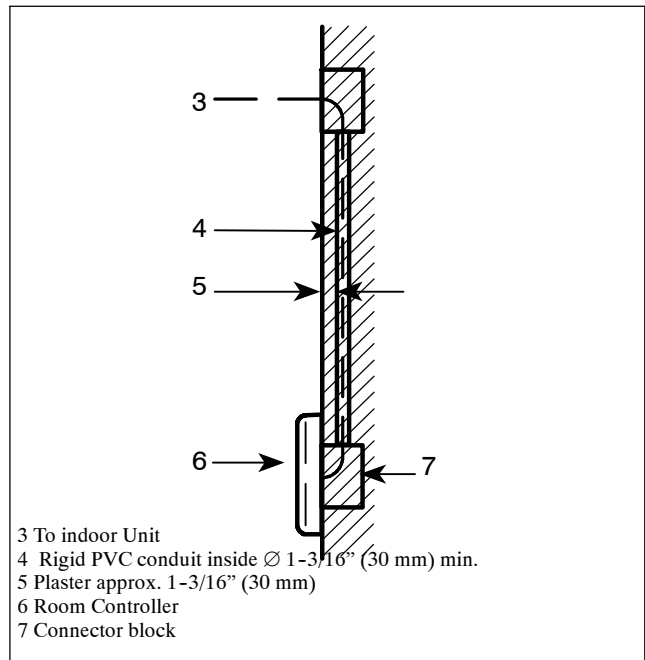

Fig. 13 – Connection Cable

- Push any excess wire into the wall and against mounting base.
If the air sensor is being used on the Room Controller, seal hole in wall to prevent air leaks.
Leaks can affect sensor operation.



- 3 To indoor Unit
- 4 Rigid PVC conduit inside \varnothing 1-3/16" (30 mm) min.
- 5 Plaster approx. 1-3/16" (30 mm)
- 6 Room Controller
- 7 Connector block

Fig. 14 – Mounting location

- Push the Room Controller snap hinge to the base.
- Tighten the side fixing screw.

33MC-URC

General information and characteristics

⚠ WARNING

ELECTRICAL SHOCK HAZARD

Failure to follow this warning could result in personal injury or death.
Before connecting any wiring to the Room Controller, turn off all power to the unit that will supply power to the Room Controller.

Diagram 1:
Connection diagram for the following units:
40KMC and 40KMQ Cassette Family

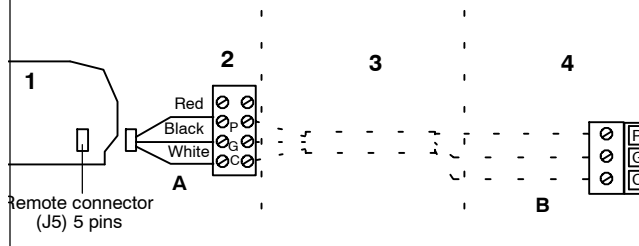

A Indoor unit

B Room Controller

1. Main electronic card
2. 4 pins terminal block placed on external control box
3. Wires supplied by the installer
4. Terminal block in the Room Controller
 - Loosen the screws of terminals P (DC Power), G (GROUND) and C (SIGNAL) on the indoor unit and Room Controller terminal blocks.
 - As shown in diagram 1 connect the indoor unit terminal block to the Room Controller terminal block.

Diagram 2:
Connection diagram for the following units:
40QNC and 40QNQ Highwall Family

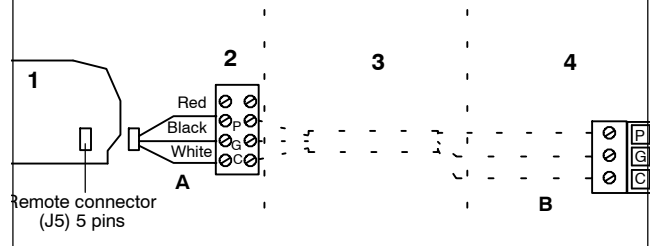

A Indoor unit

B Room Controller

1. Main electronic card
2. 4 pins terminal block placed on external control box
3. Wires supplied by the installer
4. Terminal block in the Room Controller
 - Loosen the screws of terminals P (DC Power), G (GROUND) and C (SIGNAL) on the indoor unit and Room Controller terminal blocks.
 - By means of the screw provided with the Room Controller Kit, secure the auxiliary terminal block (3 poles) to the main terminal box (6 poles).
 - As shown in diagram 2.

Cables of auxiliary terminal block	Room Controller terminal block
Red	P
Black	G
White	C

- Remove the cables from connector J5 inside the unit on the electronic card to connect the cables supplied with the Room Controller. Connect the indoor unit terminal block to the Room Controller terminal block in the same way as shown in diagram 2.

Wiring Materials required (supplied by installer)

- 1 small screwdriver.
- Standard Double insulated wire recommended.

Unit Configuration

Room Controller Configuration Setup

To enter installer setup, hold the “MODE” button down for 5 seconds. After 5 seconds, a “10” will appear. This indicates that the user is setting the first software configuration item. To check the value of configuration item 10, press the “MODE” button. The value of the Heat/Cool vs Cooling only remote configuration will be displayed along with the “SET TEMP” icon to indicate that the number displayed is the configuration data. To change the Heat/Cool vs Cooling only remote Configuration, use the “UP”/“DOWN” buttons. To move to the next setting, press the “MODE” button again and the “10” will be

The **BOLD** values are the default values from the factory.

Item	Value	Description
10	H	Heat/cool remote
	C	Cooling only remote
11	On	Room Thermistor Override Active.
	OF	Control and display room air temperature at the Room Controller control. <i>Room Thermistor Override Inactive.</i> Do not display room air temperature at the Room Controller and control to New Modular DFS room air thermistor(s).
12	C	Temperatures displayed in degrees C
	F	Temperatures displayed in degrees F

displayed. Press the up button and the display will change to “11”. The mode button will toggle the display between the software configuration index (i.e. “10”, “11”, etc.) and the configuration value. The “UP”/“DOWN” buttons will change either the index or the value, which ever is displayed at the time. Press the “FAN” SPEED button to exit Configuration Setup Mode. This mode will exit automatically after 10 seconds of no buttons being depressed. Once a configuration value is changed, the last value displayed will be the new configuration value for the Room Controller. The only way to abort a configuration change is to change the value back to its original value.

Unit Configuration

5. Configuration Item 10 — Heat pump Vs Cooling mode

- H - The Room Controller will allow and display the following modes: Off, Fan, Auto, Cool, Dry, and Heat.
- C - The Room Controller will allow and display the following modes: Off, Fan, Cool, and Dry.

6. Configuration Item 11 — Room thermistor override

- On- Room Thermistor Override active. Units will be controlled to the air temperature read in at the Room Controller.

OF- Room Thermistor Override not active.

All units will be controlled to the room air thermistors located on their own respective units.

7. Configuration Item 12 — Celsius Vs Fahrenheit

- C - Indicates that all temperatures will be displayed in degrees C.
- F - Indicates that all temperatures will be displayed in degrees F.

33MC-URC

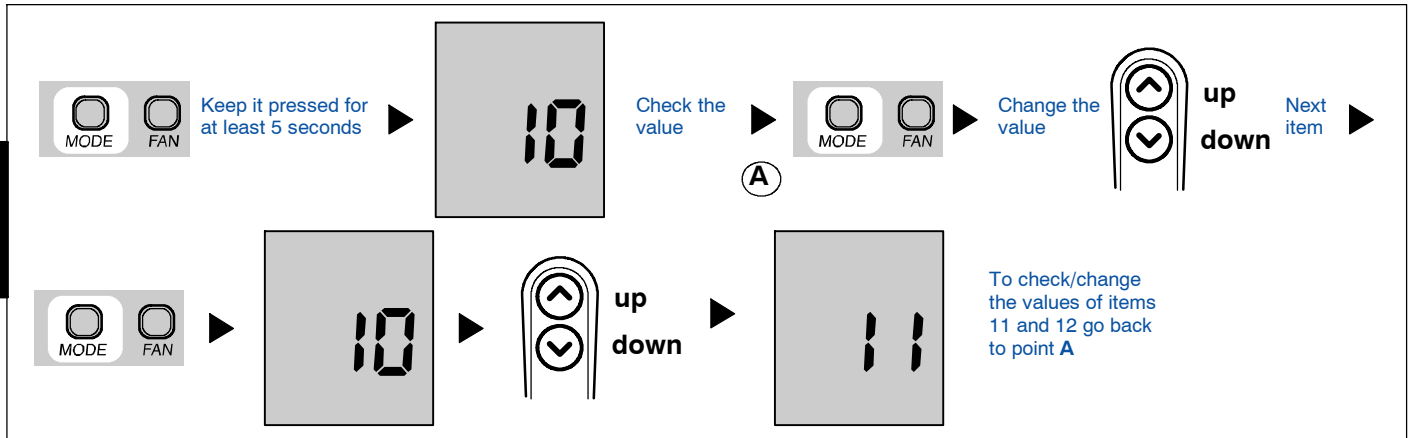

Fig. 15 – Unit Configuration Setup

Louver Mode Selection

To enter louver mode selection, make sure the Room Controller is on and hold the “FAN” SPEED button down for 5 seconds. After 5 seconds, the selected louver setting will be displayed. Depressing the up and down arrows will allow the user to modify the louver setting between swing and auto.

- The two setting will be displayed in the following way:
- “S” with Swing Louver Icon - represents Swing Louver.
- “A” with Auto Louver Icon - represents Auto Louver.

The fan icon shall also be displayed in the louver mode. Press “FAN” SPEED button to exit LOUVER Mode Selection. This mode will exit automatically after 10 seconds of no buttons being depressed.

The only way to abort a louver change, is to change the value back to its original value.

NOTE:

- If units are grouped to one Room Controller , all units will end up having the same louver value.
- Louver Mode selection is not available during OFF mode.

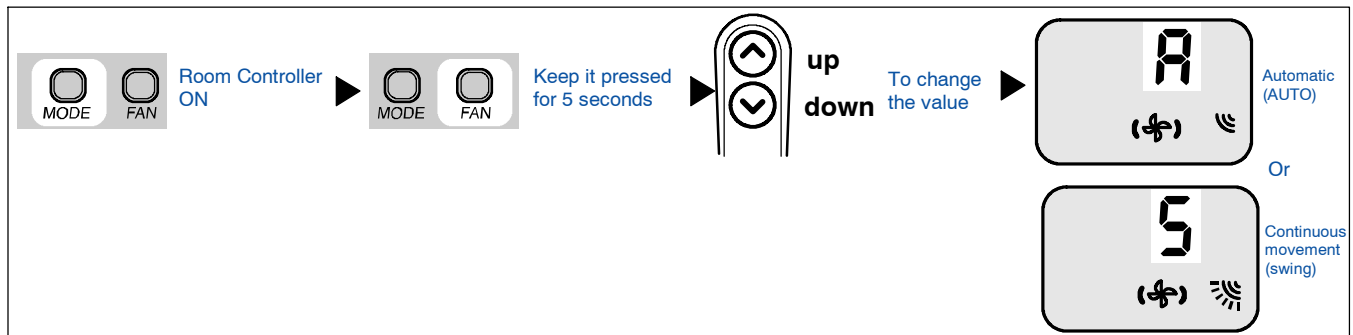

Fig. 16 – Louver Mode Selection

8. New DFS Modular Platform D Unit configuration

To enter New DFS Modular Platform D unit configuration, hold the “UP” and “DOWN” buttons down together for 5 seconds while the Room Controller is in off mode. After 5 seconds, a “20” will appear.

This indicates that the user is setting the first software configuration item. To check the value of configuration item “20”, press the “MODE” button.

The value for the New DFS Modular Platform D Heat Pump / AC Only configuration will be displayed. To change the value, use the “UP” and “DOWN” buttons. Once the value that you want is selected, press the fan button to send that configuration data to the unit.

Only the current value being displayed is transmitted. Once the “FAN” button is pressed, the Room Controller will switch to displaying the configuration index.

To move to the next setting, press the “MODE” button again and the “20” will be displayed.

Press the “UP” button and the display will change to “21”. The “MODE” button will toggle the display between the software configuration index (i.e. “20”, “21”, etc.) and the configuration value.

The “UP”/“DOWN” buttons will change either the index or the value, which ever is displayed at the time.

Unit Configuration items 20-24 are available at this point.

Unit Configuration

Item	Value	Description
20	1 : Heat pump 0 : AC Only (indoor unit with or without electric heaters)	Unit Configuration Defaults to Heat Pump
21	1 – 199 in increments of 1	CCN Address of the unit Defaults to 1 To display the hundreds, icon ON/OFF is ①.
22	0 – 199 in increments of 1	Zone number – Communications zone the system is located in Defaults to 0 To display the hundreds, icon ON/OFF is ①.
24	0 : Start in Off Mode 1 : Start in last mode	Auto Restart Defaults to “On”

This mode will exit automatically after 30 seconds of no buttons being depressed.

NOTE: If units are grouped to one Room Controller, all units will end up having the same configuration value.

Service test mode

There is a hidden service test mode that is initiated through a combination of button presses when the remote is off. The following combination must be pressed within a 6 seconds period:

DOWN-FAN-UP-FAN-MODE

Once in service test mode, the service test mode message will be sent, and “Sr” will be displayed in the temperature icons until the “DOWN” button is pressed.

During Service Test mode all the icons are off, the only button that is active is the “DOWN” button.

To cancel Service Test Mode, press the “DOWN” button to send a normal message with “OFF” mode.

Service Test Mode automatically times out after 30 minutes and the remote will operate normally.

- When test mode is selected, the unit will operate as described below:
 - The Unit Status (Green) and Timer (Yellow) LEDES blink every 2 seconds.
 - The indoor fan will operate according to user-selected speed. If user selected speed is Auto, the fan will run in High speed.
 - If the unit is configured as an A/C Only unit, it will operate in cool mode with demand.
- The louver will operate according to user-selected position. If user selected louver is Auto, louver operates according to cool louver.
 - If the unit is configured as a Heat Pump unit, the louver will operate according to user-selected position. If user selected louver is Auto, louver operates according to auto heat or cool louver based on operating mode.
 - The unit will run in cool mode for 3 minutes, then it will run in heat mode for 2 minutes, or until the indoor coil is greater than 104°F. The unit will run in cool mode until test mode is exited.

Any of the following will cancel the test Mode:

- When the unit is turned off by the controller.
- If the power is cycled during the Test Mode, the unit will return to its normal operating mode.
- After 30 minutes of receiving the last valid test request message.
- Fail Mode

Troubleshooting

Symptom	Possible Cause	Things to check	Solution
No LCD display	1) mis-wiring of the 12 volt power to Room Controller control.	Verify that + 12 V and Ground are connected to the proper terminals of the Controller. Reference Installation wiring section for correct connections	After disconnecting the power, correct the wiring problem and re-cycle power.
	2) Power not online	Check that the units main power is connected. The main control board should be operating normally	After verifying the wiring to the Room Controller, re-cycle the unit power.
	3) No 12 volts between P and G of terminal block.	Check the installation of the J6 plug on the main control board.	After disconnecting the power, correct the wiring problem and re-cycle power.
+ 12 volts applied to Room Controller at the correct terminals and still does not operate	1) The Room Controller is damaged.		Change the Room Controller and re-cycle power.

