

Part Numbers P707-SER1504N and 2004N

**CONTENTS**

**SAFETY CONSIDERATIONS**..... 1

**GENERAL**..... 1

**INSTALLATION**..... 2-10

**Step 1 — Unit Location**..... 2

**Step 2 — Unit Mounting**..... 2

**Step 3 — Locate and Install Weather Hoods**..... 3

**Step 4 — Install Ducting to Weather Hood**

**Location**..... 3

**Step 5 — Install Indoor Ductwork System**..... 3

- SUPPLY AIR DUCTING
- EXHAUST AIR DUCTING
- INSTALL DUCTING
- INSTALLATION EXAMPLES

**Step 6 — Airflow Balancing**..... 8

- AIRFLOW STATION METHOD
- PITOT TUBE BALANCING PROCEDURE
- BALANCING DAMPER ADJUSTMENT

**Step 7 — Install Accessories**..... 9

**Step 8 — Electrical Connection to Furnace**  
(Air Systems Directly Connected to Furnace) .. 9

**OPERATION**..... 11

**Spring**..... 11

**Summer**..... 11

**Fall**..... 11

**Modes of Operation**..... 11

- CONTINUOUS/VENTILATION MODE
- INTERMITTENT/STANDBY MODE

**MAINTENANCE**..... 11

**Motor**..... 11

**Chassis**..... 11

**Condensation Panel**..... 11

**Outside Hoods**..... 11

**Filters**..... 11

**Enthalpic Core**..... 11

**TROUBLESHOOTING**..... 12

**SAFETY CONSIDERATIONS**

Installing, starting up, and servicing ventilation equipment can be hazardous due to system pressures, electrical components and equipment location (roofs, elevated structures, etc.). Only trained, qualified installers and service mechanics should install, start up, and service this equipment.

When working on the equipment, observe precautions in the literature and on tags, stickers, and labels attached to the equipment. Follow all safety codes.

**⚠ WARNING**

Before installation, always check to be sure main power to systems are OFF. Electrical shock can cause personal injury or death.

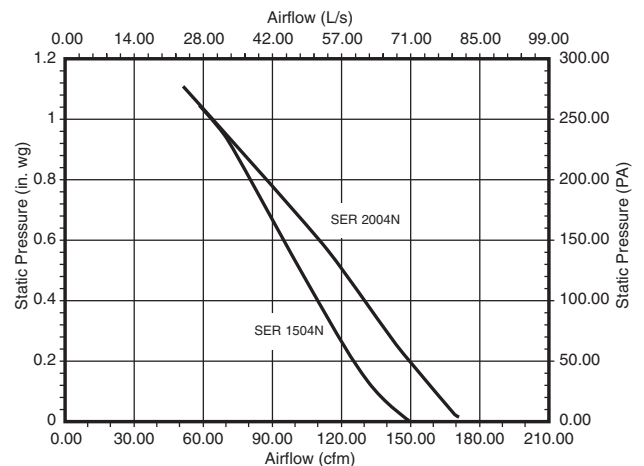
**GENERAL**

The P707-SER1504N and P707-SER2004N Energy Recovery Ventilators (ERV) are used to exchange indoor stale air with outside fresh air. The ERV unit is equipped with a special energy recovery core which transfers sensible and latent heat with the fresh incoming air. The cross-flow design core allows entering and leaving airstreams to transfer heat energy without mixing.

The ERV is available in 2 sizes with airflow ranges of 150 cfm (SER1504N), and 200 cfm (SER2004N). The design of this unit is horizontal. Special attention should be given to duct application, balancing the ERV, and locating unit for easy access and routine maintenance. See Table 1 and Fig. 1 for performance data.

**⚠ CAUTION**

The P707-SER1504N and 2004N Energy Recovery Ventilators contain an enthalpic core that is not designed to function in climates in which freezing weather conditions may occur (below 32 F). Using the enthalpic core in freezing weather conditions will damage the enthalpic core and void the warranty.



**Fig. 1 — Fan Performance**

**Table 1 — Performance Data**

UNIT	APPARENT SENSIBLE EFFECTIVENESS AT 32 F (0° C)	TOTAL RECOVERY EFFICIENCY AT 95 F (35 C)
P707-SER1504N	82%	58%
P707-SER2004N	92%	66%

## INSTALLATION

**Step 1 — Unit Location** — The ERV must be located in a heated space where it can be conveniently serviced. Typically the ERV is located in the mechanical room or an area close to the outside wall where the weather hoods will be mounted. If a basement area is not convenient or does not exist, a utility or laundry room may be used. See Fig. 2 for dimensions.

Attic installations are not normally recommended due to the complexity of work to install, freezing conditions in the attic, and the difficulty of access for service and cleaning.

**Connecting appliances to the ERV** is not recommended (such as a clothes dryer, range top, stovetop fan, or central vacuum system). These appliances may cause lint, dust or grease to collect in the ERV, damaging the unit.

**NOTE:** Connecting any of these type of appliances to the ERV will invalidate the warranty.

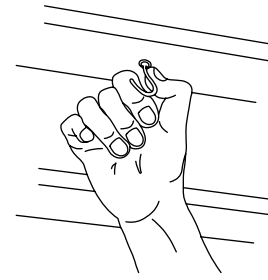
Locate the unit close to the outside wall on which the supply and exhaust hoods will be mounted. There should be a nearby power supply of 120 volts, 60 Hz available.

The unit should be located in a heated area (attic installation is not recommended). The location should also minimize any noise level that would be created by the unit in the living area.

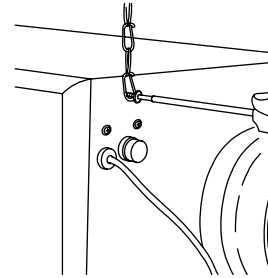
Make sure there is adequate access for future maintenance.

**Step 2 — Unit Mounting** — The unit is typically hung from the ceiling for mounting. See Fig. 2 for unit dimensions. Perform the following to mount the ERV:

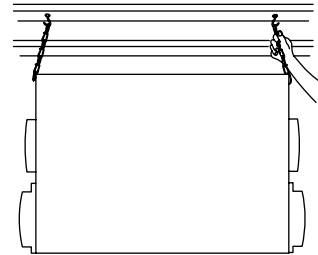
1. Place fastening hooks on the strapping board or the floor joists. See Fig. 3.
2. Attach a hanging chain (provided) to each no. 10 <sup>3</sup>/<sub>4</sub>-in. bolts (provided) on the top 4 corners of the unit and tighten. See Fig. 4.
3. Hang the unit by slipping a link onto the hanging hooks, making sure the unit is level. See Fig. 5.



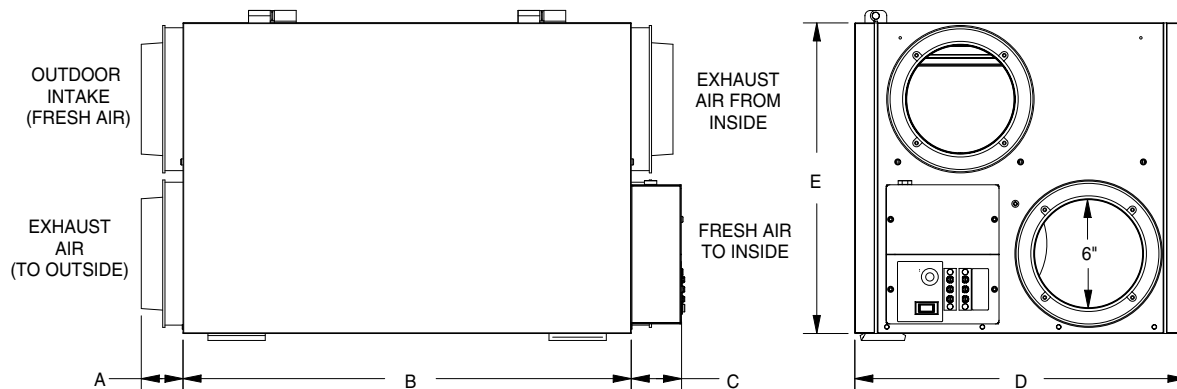
**Fig. 3 — Install Fastening Hooks**



**Fig. 4 — Install Hanging Chain**



**Fig. 5 — Unit Mounting**



UNIT	A	B	C	D	E
P707-SER1504N	2 <sup>1</sup> / <sub>4</sub> " (56 mm)	23 <sup>1</sup> / <sub>2</sub> " (596 mm)	2 <sup>5</sup> / <sub>8</sub> " (67 mm)	17 <sup>3</sup> / <sub>8</sub> " (441 mm)	16 <sup>1</sup> / <sub>8</sub> " (413 mm)
P707-SER2004N	2 <sup>1</sup> / <sub>4</sub> " (56 mm)	27 <sup>7</sup> / <sub>8</sub> " (707 mm)	2 <sup>5</sup> / <sub>8</sub> " (67 mm)	17 <sup>3</sup> / <sub>8</sub> " (441 mm)	20 <sup>1</sup> / <sub>2</sub> " (520 mm)

**Fig. 2 — Unit Dimensions**

### Step 3 — Locate and Install Weather Hoods —

The intake weather hood should be located upstream and at least 4 to 6 ft away from the exhaust weather hood. The intake weather hood should be at least 6 ft away from dryer vents and furnace exhaust (on medium or high efficiency furnaces) and a minimum of at least 6 ft from driveways, oil fill pipes, gas meters, or garbage containers.

Locate the hoods at least 18 in. above the ground, or above the depth of expected snow accumulation. The hoods should be at least 3 ft from the corner of the building. Do not locate in a garage, attic or crawl space.

A well designed and installed ducting system will allow the ERV to operate at its maximum efficiency. Always keep duct runs as short and straight as possible.

To install the intake and exhaust weather hoods, perform the following:

1. Using the collar of the outside hood, outline the intake and exhaust holes to be cut. The hole should be slightly larger than the collar to allow for the thickness of the insulated flexible duct. See Fig. 6.
2. Cut a hole using the outline from Step 1. See Fig. 6. When cutting or drilling holes, be careful not to damage electrical wiring or other hidden objects in wall.
3. Pull the insulated flexible duct through the opening until it is well extended and straight. Slide the duct inner vinyl sleeve over the hood collar and secure. See Fig. 7.
4. Pull the insulation over the duct and then the vapor barrier over the sleeve and secure with duct tape. See Fig. 7.
5. Push the hood into the opening. Attach the hood to the outside wall with mounting screws. See Fig. 8.
6. Using a caulking gun, seal around the hoods to prevent any leaks. See Fig. 9.

### Step 4 — Install Ducting to Weather Hood Location —

The inner liner of the flexible insulated duct was secured to the intake and exhaust weather hoods in Step 3. Run the other end of the flexible duct to the ERV installation location. See Fig. 10.

Clamp the end of the duct to the appropriate port on the ERV. See Fig. 2.

The insulation should remain full and not be crushed. The outer liner, which acts as a vapor barrier must be completely sealed to outer wall and the ERV using tape and/or caulking. A good bead of high quality caulking (preferably acoustical sealant) will seal the inner flexible duct to both the ERV port and the weather hood prior to clamping.

To minimize airflow restriction, the flexible insulated duct that connects the two outside weather hoods to the ERV should be stretched tightly and be as short as possible. Twisting or folding the duct will severely restrict airflow.

### Step 5 — Install Indoor Ductwork System —

To maximize airflow in the ductwork system, all ducts should be kept short and have as few bends or elbows as possible. Forty-five degree elbows are preferred to 90 degree elbows. Use tees instead of 90 degree elbows whenever possible.

All duct joints must be fastened with screws or duct sealant and wrapped with a quality duct tape to prevent leakage. Aluminum foil duct tape is recommended. Galvanized ducting from the ERV to the living areas in the house is recommended whenever possible, although flexible duct can be used in moderation when necessary.

**SUPPLY AIR DUCTING** — In homes without a forced air furnace, fresh air should be supplied to all high-usage rooms including bedrooms and living areas. Air should be supplied from high wall or ceiling locations. Grilles that diffuse the air comfortably are recommended. To avoid possible noise transfer through the ductwork system, a short length (approximately 12 in.) of nonmetallic flexible insulated duct should be connected between the ERV and the supply/exhaust ductwork system.

The main supply and return lines to and from the ERV must be 6 in. minimum. Branch lines to the individual rooms may be as small as 4 in., but 5 in. lines are preferred. If floor installation is the only option available, then special care should be taken in locating grilles. Installation areas, such as under baseboard heaters, will help to temper the air. In homes with a forced air furnace, it may be advisable to connect the ERV to the furnace ductwork (direct connection).

Building Codes and Combustion Appliance Installation Codes do not allow location of return air grilles or any opening such as a breathing tee in an enclosed room with spillage susceptible combustion appliances.

The fresh air inlet from the ERV must be a minimum distance of 3 ft from the furnace return drop to ensure proper air mixing and temperature at the furnace core.

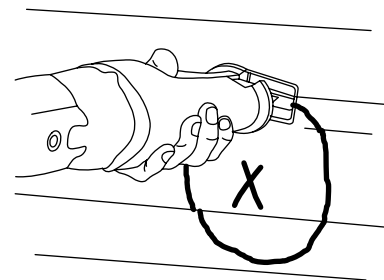


Fig. 6 — Cut Holes for Weather Hoods

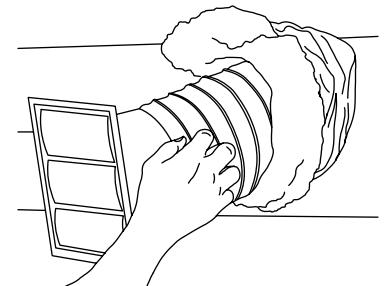


Fig. 7 — Install Duct and Sleeve

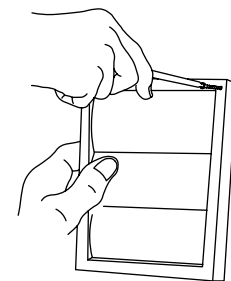
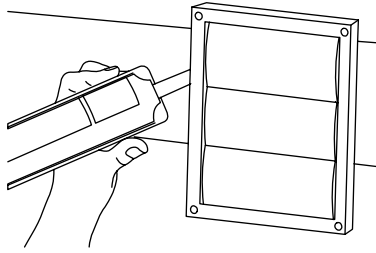
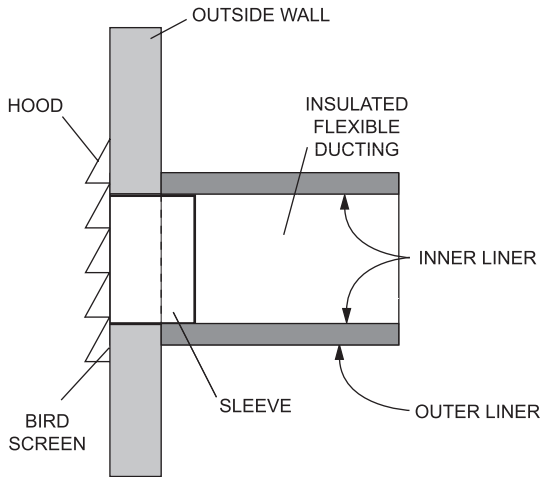


Fig. 8 — Install Hoods



**Fig. 9 — Seal Hoods**



**Fig. 10 — Outdoor Ducting Installation**

**Direct Connection** — A direct connection requires that the furnace fan run continuously. See Fig. 11. The fan may be inter-linked electrically (low voltage) with the ERV accessory control contacts for intermittent demand.

To hard duct the supply air directly into the cold air return of the furnace, remember to check the airflow balance of the ERV with the furnace fan both on and off to determine that it does not imbalance the ERV more than 10%. Make sure that the minimum distance from the supply air of the ERV to the furnace is followed. Refer to the local and National Building and Heating Codes for any variations in these notes.

**IMPORTANT:** In very humid climates, it is *preferable* to have a dedicated ducting system to the house for the ERV instead of connecting the ERV to the central air conditioner. Since the central air conditioner fan must be running continuously to allow the fresh air from the ERV to be properly distributed throughout the house, it may pick up humidity from the cooling coil when it is not operating and redistribute it to the house, causing excess humidity. This situation will be particularly aggravated if the air conditioner is over sized.

**Indirect Connection** — The fresh air from the ERV may be directed at a grille installed in the cold air return duct of the furnace. In this installation, the supply outlet should be a minimum of 4-in. and a maximum of 12-in. from the furnace return air inlet. The forced air system should include a two-speed fan. See Fig. 12.

Except when high speed is required for heating, the fan should operate continuously on low speed. Accordingly, fresh air will be supplied without affecting the comfort of the occupants. The installation can also be done with a breathing tee. Refer to the local and National Building and Heating Codes for any variations in these notes.

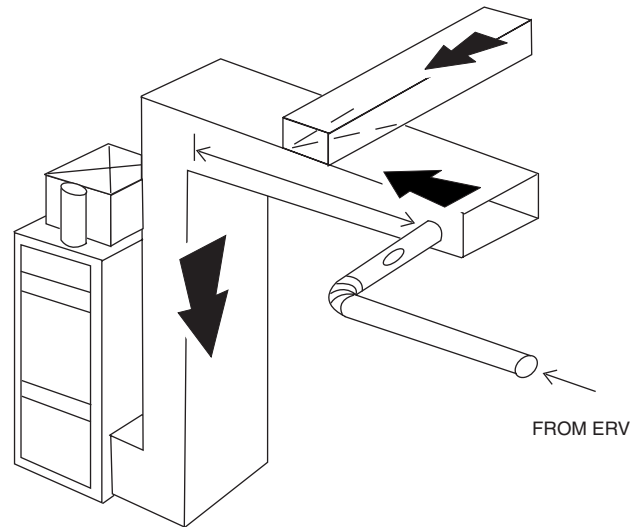
**EXHAUST AIR DUCTING** — The stale air exhaust system is used to draw air from the points in the house where the worst air quality problems occur. It is recommended that return air ducts be installed in the bathroom, kitchen, and laundry room. Additional return air ducts from strategic locations (i.e., greenhouse, atrium, swimming pool, sauna, etc.) may be installed. The furnace return duct may be also used.

In this method, the exhaust air is not ducted back from bathrooms, kitchens, etc. to the ERV with dedicated lines.

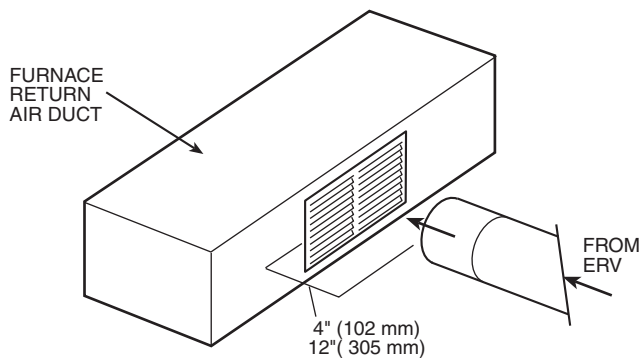
This method has become popular and provides good ventilation when installed in accordance with the instructions. The furnace blower must be running when the ERV is operating for this method to be effective.

**INSTALL DUCTING** — To install indoor ductwork, perform the following:

1. Begin with the duct collar on the ERV marked Exhaust Air In. Slide a short piece (12-in.) of flexible duct over the duct collar. Using duct tape, tape the flexible duct to the collar.
2. Run the flexible ducting to the main rigid duct trunk line, which connects to the remainder of the ducts going to and from rooms in the house. Repeat the steps for the Supply Air Out on the side of the ERV.
3. Working from a closet, attic or inside joist wall, run the length of ducting required for the proper grille location and cut a hole in the wall.
4. Fasten the mounting collar (field-supplied) to the ducting and fasten the collar to the wall or ceiling with screws.
5. The field-supplied grille may be adjustable. It is recommended that the grilles be completely opened at first and then adjusted later as needed.
6. Push the grille into the mounting collar or directly into installed elbow.



**Fig. 11 — Direct Duct Connection**



**Fig. 12 — Indirect Duct Connection**

**INSTALLATION EXAMPLES** — It is the responsibility of the installer to ensure all ductwork is sized and installed as designed to ensure the system will perform as intended. All air movement devices have a performance curve. The amount of air (cfm) that an ERV will deliver is directly related to the total external static pressure (E.S.P.) of the system. Static pressure is a measure of resistance imposed on the blower by length of duct work/number of fittings used in ductwork, duct heater etc.

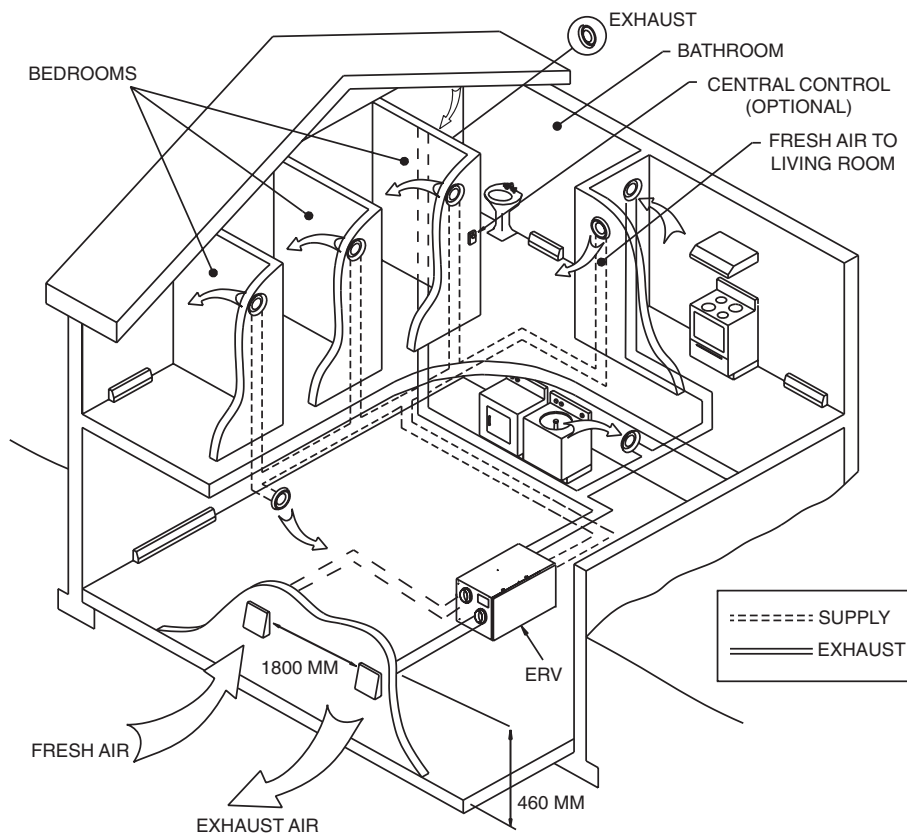
**IMPORTANT:** In very humid climates, it is *preferable* to have a dedicated ducting system to the house for the ERV instead of connecting the ERV to the central air conditioner. Since the central air conditioner fan must be running continuously to allow the fresh air from the ERV to be properly distributed throughout the house, it may pick up humidity from the cooling coil when it is not operating and redistribute it to the house, causing excess humidity. This situation will be particularly aggravated if the air conditioner is over sized.

**Fully Dedicated System (New Construction)** — Stale air is drawn from key areas of the home (bathroom, kitchen, laundry). Fresh air is supplied to main living areas. The ERV must be balanced. See Fig. 13.

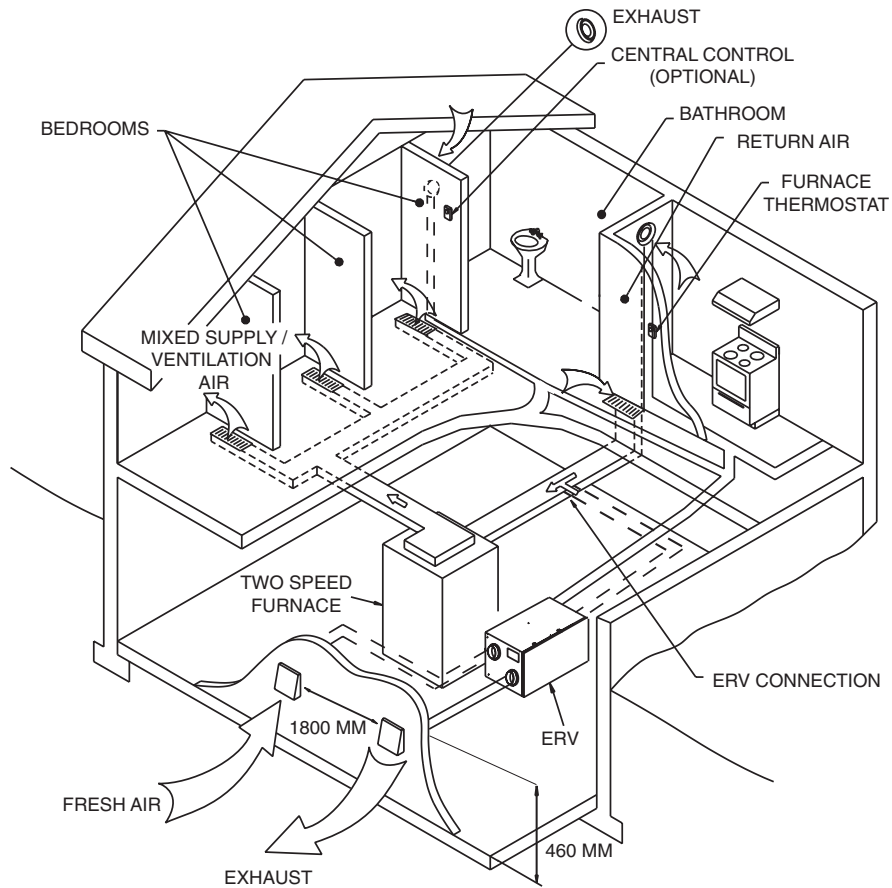
**Partially Dedicated System** — Stale air is drawn from key areas of the home (bathroom, kitchen, laundry) and fresh air is supplied to main living areas via the forced air system. The ERV must be balanced. See Fig. 14 and 15.

**Direct Connection of Supply Airstream and Exhaust Airstream to the Furnace Cold Air Return (Return/Return Method)** — The ERV must be balanced. It is mandatory that the furnace blower run continuously or ERV operation be interlocked with the furnace blower. Check local codes/authority having jurisdiction for acceptance. See Fig. 16 and 17.

**Direct Connection of Both Supply Airstream and Exhaust Airstream to the Furnace Cold Air Return and Supply Air Side (Supply/Return Method)** — The ERV must be balanced. It is recommended that the furnace blower run continuously or ERV operation be interlocked with the furnace blower. Check local codes and/or authority having jurisdiction for acceptance. See Fig. 18 and 19.

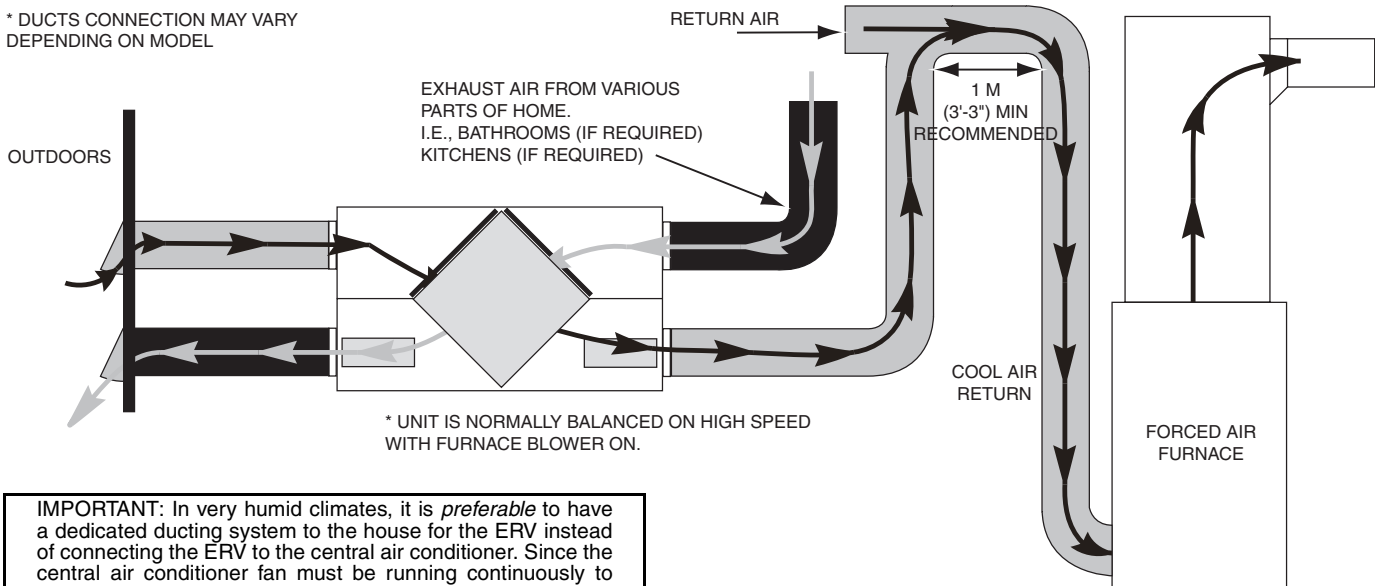


**Fig. 13 — Fully Dedicated System (Preferred Installation)**



**Fig. 14 — Partially Dedicated System**

\* DUCTS CONNECTION MAY VARY DEPENDING ON MODEL

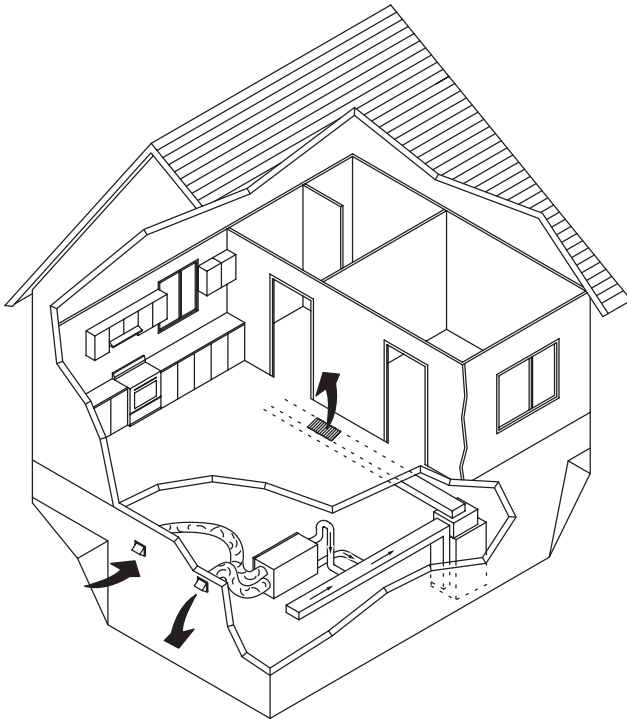


**IMPORTANT:** In very humid climates, it is *preferable* to have a dedicated ducting system to the house for the ERV instead of connecting the ERV to the central air conditioner. Since the central air conditioner fan must be running continuously to allow the fresh air from the ERV to be properly distributed throughout the house, it may pick up humidity from the cooling coil when it is not operating and redistribute it to the house, causing excess humidity. This situation will be particularly aggravated if the air conditioner is over sized.

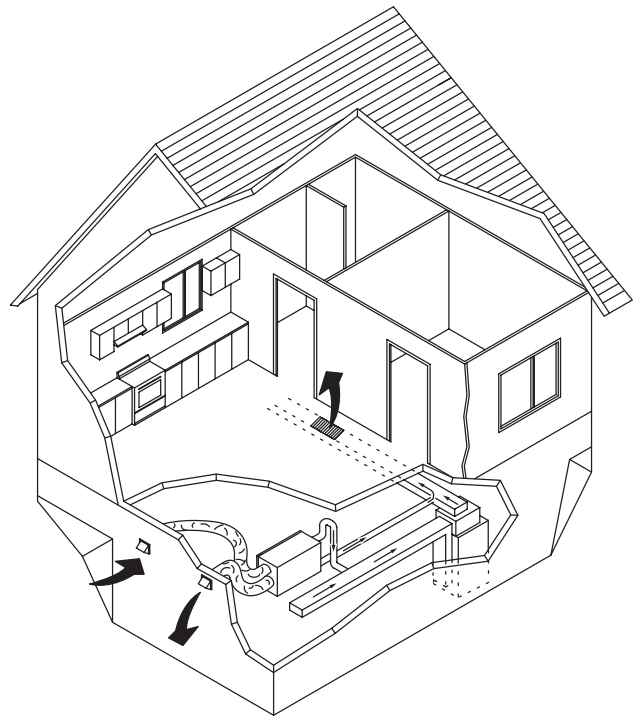
**NOTES:**

1. Furnace blower may be required to operate when ERV is on to provide good air distribution.
2. Weather hood arrangement is for drawing purposes only. 6 ft (2 m) minimum separation recommended. 18 in. (460 mm) above grade minimum.
3. Due to the differences in pressure between the ERV and the equipment it is being connected to, the ERV's airflow must be confirmed on site, using the balancing procedure found in the installation manual.

**Fig. 15 — Partially Dedicated System Airflow Diagram**

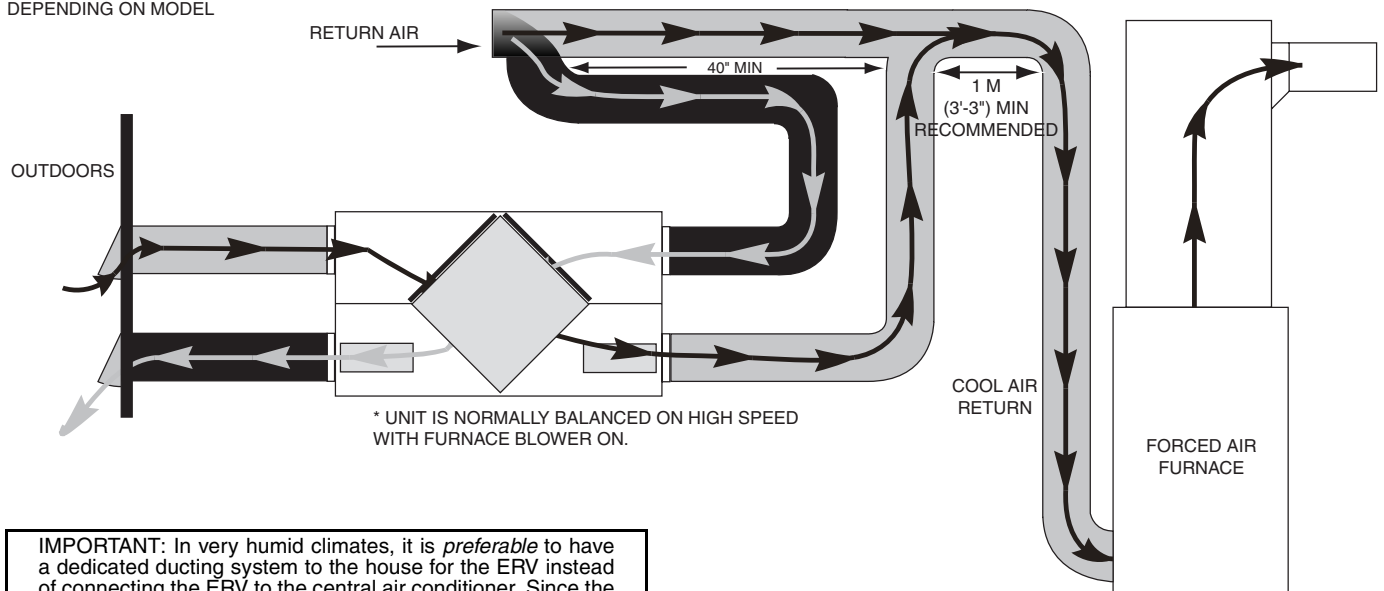


**Fig. 16 — Direct Connection to Furnace (Return/Return)**



**Fig. 18 — Direct Connection to Furnace (Supply/Return)**

\* DUCTS CONNECTION MAY VARY DEPENDING ON MODEL



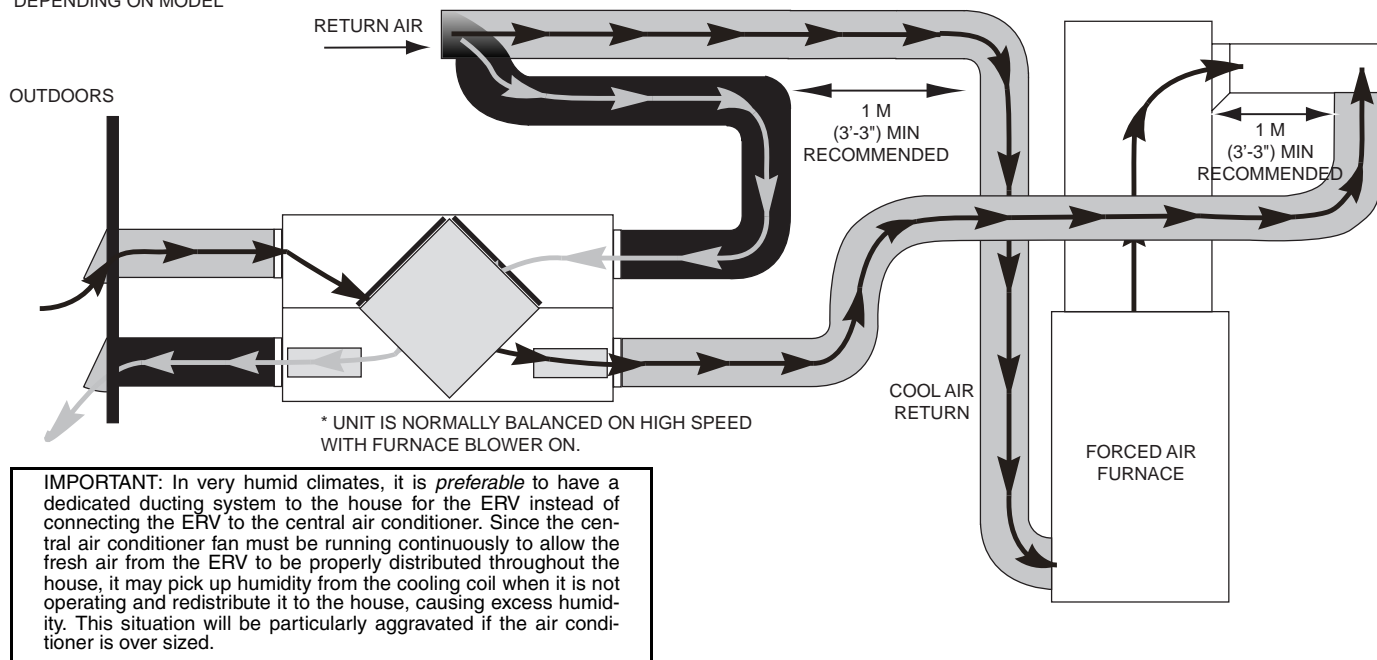
**IMPORTANT:** In very humid climates, it is *preferable* to have a dedicated ducting system to the house for the ERV instead of connecting the ERV to the central air conditioner. Since the central air conditioner fan must be running continuously to allow the fresh air from the ERV to be properly distributed throughout the house, it may pick up humidity from the cooling coil when it is not operating and redistribute it to the house, causing excess humidity. This situation will be particularly aggravated if the air conditioner is over sized.

**NOTES:**

1. Furnace blower may be required to operate when ventilation from ERV is required. The furnace should be set to run continuously or interlocked with ERV.
2. A minimum separation of 39 inches (1 m) is required between the two direct connections.
3. The exhaust air connection should be upstream of the supply air connection to prevent exhausting any fresh air.
4. Weather hood arrangement is for drawing purposes only. 6 ft (2 m) minimum separation recommended. 18 in. (460 mm) above grade minimum.
5. Due to the differences in pressure between the ERV and the equipment it is being connected to, the ERV's airflow must be confirmed on site, using the balancing procedure found in the installation manual.

**Fig. 17 — Direct Connection to Furnace (Return/Return) Airflow Diagram**

\* DUCTS CONNECTION MAY VARY  
DEPENDING ON MODEL



**IMPORTANT:** In very humid climates, it is *preferable* to have a dedicated ducting system to the house for the ERV instead of connecting the ERV to the central air conditioner. Since the central air conditioner fan must be running continuously to allow the fresh air from the ERV to be properly distributed throughout the house, it may pick up humidity from the cooling coil when it is not operating and redistribute it to the house, causing excess humidity. This situation will be particularly aggravated if the air conditioner is over sized.

**NOTES:**

1. Furnace blower may be required to operate when ventilation from ERV is required. The furnace should be set to run continuously or interlocked with ERV.
2. The exhaust air connection should be upstream of the supply air connection to prevent exhausting any fresh air.
3. Weather hood arrangement is for drawing purposes only. 6 ft (2 m) minimum separation recommended. 18 in. (460 mm) above grade minimum.
4. Due to the differences in pressure between the ERV and the equipment it is being connected to, the ERV's airflow must be confirmed on site, using the balancing procedure found in the installation manual.

**Fig. 19 — Direct Connection to Furnace (Supply/Return) Airflow Diagram**

**Step 6 — Airflow Balancing** — If the unit airflows are not properly balanced then the unit may not operate at maximum efficiency and energy recovery core damage may occur.

An improperly balanced unit could cause negative or positive pressure in the home causing cold air to enter or other combustible equipment to backdraft.

The balancing procedure consists of measuring the exhaust air leaving the system and the supply air entering the system and ensuring that these two are equal. A deviation of 10% or less is acceptable. In such cases, it is recommended to have a greater amount of exhaust air than supply which will increase the supply-air temperature.

**AIRFLOW STATION METHOD** — To measure airflow with an airflow station, perform the following:

1. Cut the duct and insert the flow measuring station. Make sure that the flow measuring station air direction arrow points in the direction of the airflow. Secure the flow measuring station with duct tape. See Fig. 20.
2. Before taking the reading, make sure that the Magnehelic gage is level and at 0. See Fig. 21.
3. Start the ERV and other system devices if applicable (furnace and air handler) and refer to the flow measuring station chart to determine unit airflow velocity.
4. The airflow is regulated by a balancing damper located inside the collar of the ERV. Adjust the Supply Air Out damper until the desired velocity is achieved. See Fig. 22.
5. Adjust the Exhaust Air Out damper in the same manner.

**PITOT TUBE BALANCING PROCEDURE** — The following is a method of field balancing an ERV using a Pitot tube. This is advantageous in situations when flow stations are not installed in the ductwork. The procedure should be performed with the ERV on high speed. See Fig. 23.

1. Operate all mechanical systems on high speed which have an influence on the ventilation system (i.e., ERV, forced air furnace, or air handler) if applicable. This will provide the maximum pressure that the ERV will need to overcome, and allow for a more accurate balance of the unit.
2. Drill a small hole in the return duct (about  $\frac{3}{16}$ -in.), 3 ft downstream of any elbows or bends, and 1 ft upstream of any elbows or bends. These are recommended distances but the actual installation may limit the amount of straight duct.
3. The Pitot tube should be connected to a Magnehelic gage or other manometer capable of reading from 0 to 0.25 in. wg, preferably to 3 digits of resolution. The tube coming out of the top of the pitot is connected to the high pressure side of the gage. The tube coming out of the side of the pitot is connected to the low pressure or reference side of the gage.
4. Insert the pitot tube into the duct; pointing the tip into the airflow. For general balancing it is sufficient to move the pitot tube around in the duct and take an average or typical reading.
5. Repeat this procedure in the supply duct. Determine which duct has the highest airflow (highest reading on the gage).
6. Use the ERV dampers to correct the airflow to match the lower reading from the other duct. The flows should now be balanced.
7. Actual airflow can be determined from the gage reading. The value read on the gage is called the velocity pressure. The pitot tube comes with a chart that will give the airflow velocity based on the velocity pressure indicated by the gage. This velocity will be in either feet per minute or meters per second. To determine the actual airflow, the velocity is multiplied by the cross-sectional areas of the duct being measured.



This is an example for determining the airflow in a 6-in. duct. The pitot tube reading was 0.025 inches of water. From the chart, this is 640 feet per minute.

The 6-in. diameter duct has cross-sectional area of:

$$\text{Area} = \text{Pi} \times \text{Radius}^2$$

$$6\text{-in.} / 2 = 3\text{-in. radius}$$

$$3\text{-in.} / 12 = 0.25 \text{ ft radius}$$

$$A = 3.14 \times (0.25)^2$$

$$A = 0.2 \text{ sq ft}$$

The airflow is then:

$$640 \text{ ft/min} \times 0.2 \text{ sq ft} = 128 \text{ cfm}$$

For convenience, the cross sectional area of some common round ducts are listed below:

DUCT DIAMETER (in.)	AREA (sq ft)
5	0.14
6	0.20
7	0.27
8	0.35

The accuracy of the airflow reading will be affected by how close to any elbows or bends the readings are taken. Accuracy can be increased by taking an average of multiple readings.

**BALANCING DAMPER ADJUSTMENT** — Installation where the ERV is ducted directly to the return of a furnace may require additional dampening on the fresh air to building duct. This is due to the high return static pressures found in some furnace installations.

A butterfly damper is provided for field-installation in the fresh air to building duct. Install the damper and adjust as necessary.

**Step 7 — Install Accessories** — Install all accessories. Field-installed accessories include:

- Remote Intellitek control
- Dehumidistat
- Remote override timer

Refer to the accessory installation instructions for more information. See Fig. 24 for wiring.

**Step 8 — Electrical Connection to Furnace (Air Systems Directly Connected to Furnace)** — When the ERV is directly connected to the furnace, the furnace may need to be interlocked with the ERV to provide air circulation for the system. Connect the R and G

terminals on the furnace to the COM and N.O. terminals on the ERV. See Fig. 25 for a wiring diagram. Never connect a 120-vac circuit to the terminals of the ERV control contacts. Use only low-voltage furnace blower control contacts.

On some older thermostats, energizing the R and G terminals at the furnace has the effect of energizing Y at the thermostat and therefore energizing the cooling system. For these thermostats, use the alternate control contacts wiring. See Fig. 26.

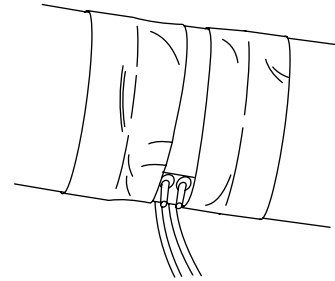


Fig. 20 — Secure Airflow Station

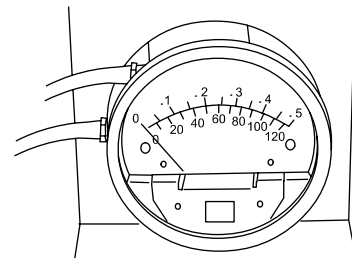


Fig. 21 — Magnehelic Gage

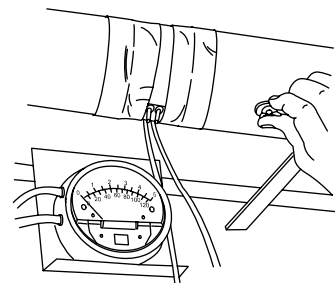
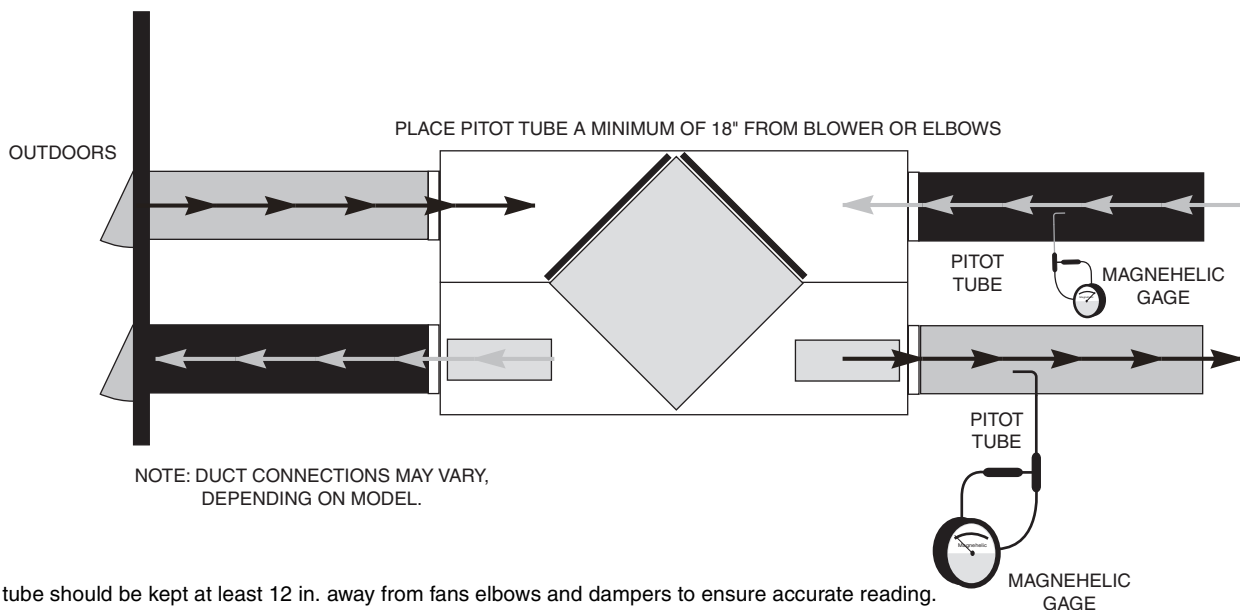
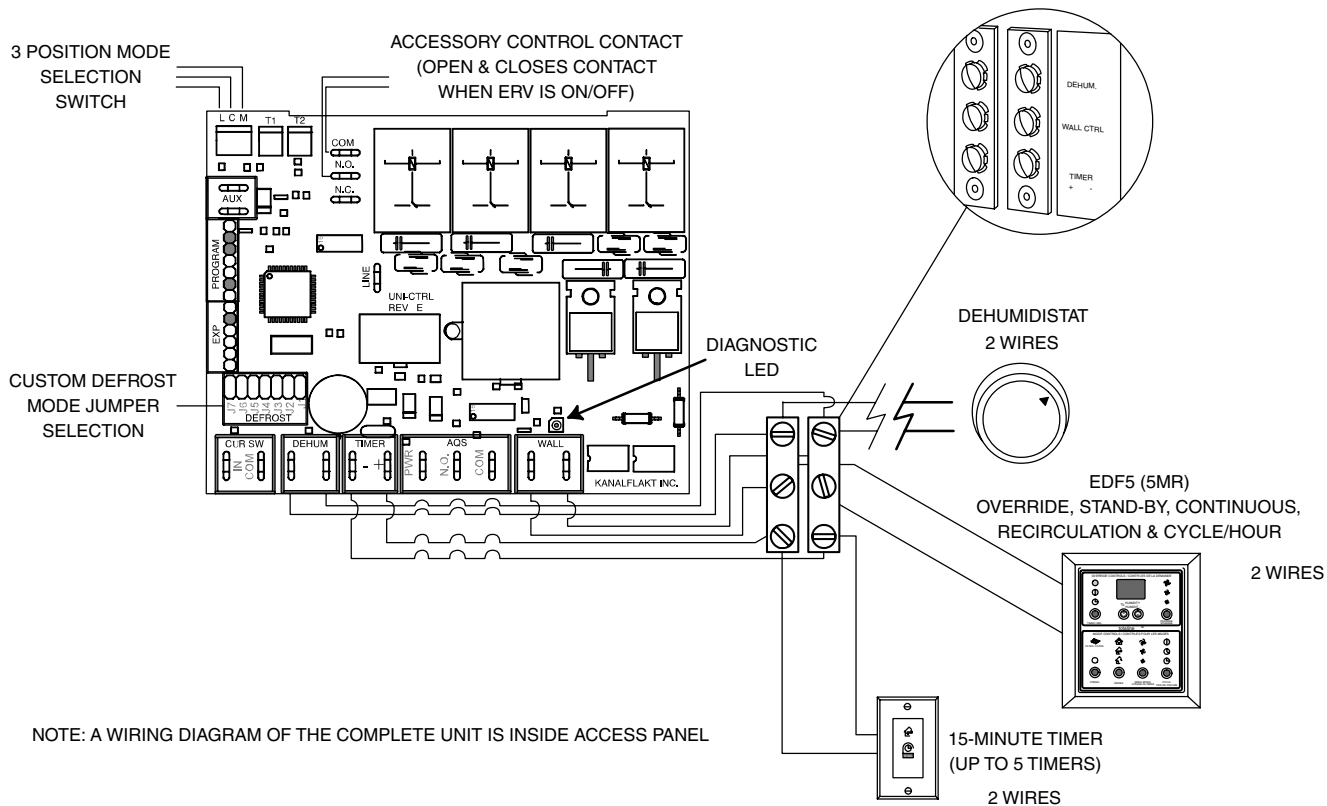


Fig. 22 — Adjust Damper Position

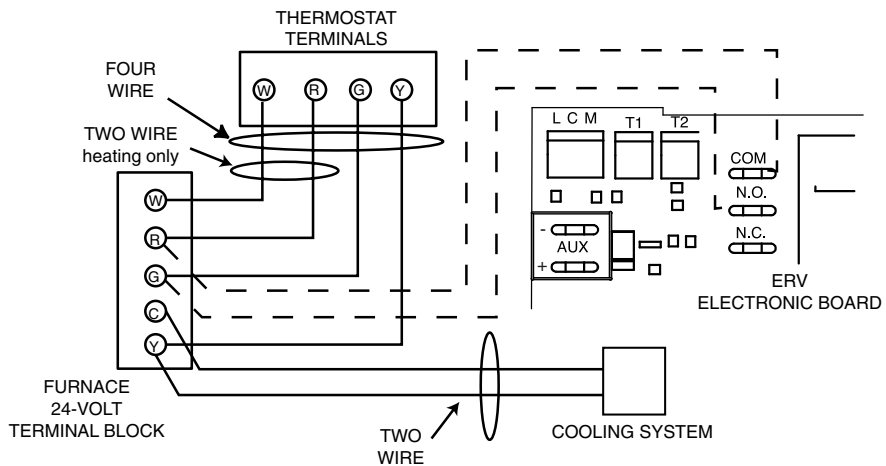


\*Pitot tube should be kept at least 12 in. away from fans elbows and dampers to ensure accurate reading.

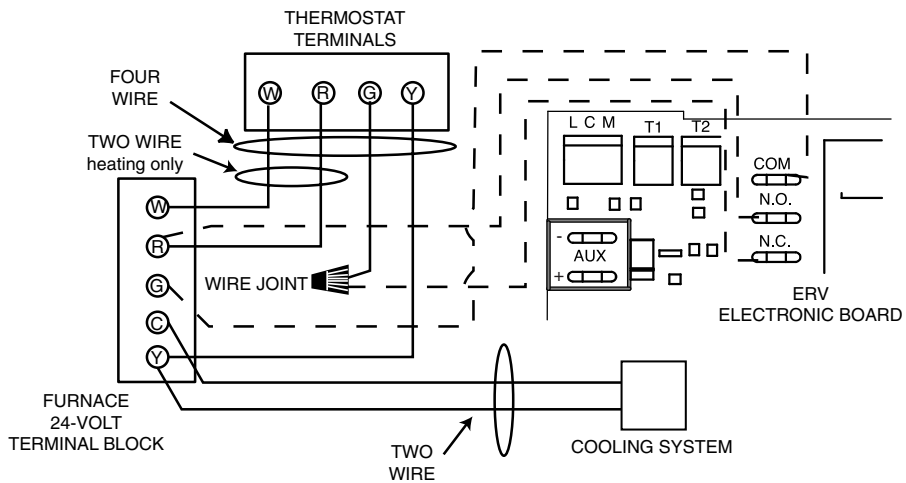
Fig. 23 — Pitot Tube Balancing



**Fig. 24 — Electrical Connections**



**Fig. 25 — Control Contact Wiring**



**Fig. 26 — Alternate Control Contact Wiring**

## OPERATION

The Energy Recovery Ventilator is designed to provide fresh into a building while exhausting an equal amount of stale air. During the winter months, the incoming cold fresh air is warmed by utilizing the energy recovered from the stale air before it is exhausted to the outdoors. During summer months when the indoor space is air conditioned, the ERV will help in cooling the incoming fresh air with the stale air that is being exhausted.

The ERV is designed to run continuous or on intermittent, giving the homeowner complete control over their air quality. Continuous low speed ventilation is recommended, which will help eliminate carbon dioxide and other gases as well as freshen up the home. Intermittent high speed ventilation can be obtained through a variety of optional remote controls.

**Spring** — Temperatures are more moderate and become warmer each day. To keep the humidity and temperature uniform, set the dehumidistat higher and the switch on the ERV to standby.

**Summer** — The air is sometimes hot and humid. To stop the warm humid air from entering, set the dehumidistat at its highest level and the switch on the ERV to standby. If the Intellitek series controller is installed, the air exchanger can be stopped at any time by turning the ERV off from the wall control. However, continuous ventilation is recommended.

**Fall** — Rain and rapid temperature changes make it difficult to control the internal humidity level and may result in condensation on the windows. A remote dehumidistat may help give greater control over the inside environment.

**Modes of Operation** — The control board offers stand-alone operating capabilities as well as an exclusive 2 wire communication to most external controls. The trouble-free accessory controls include: a rotary dial dehumidistat, a 15-minute remote push-button timer, as well as the most sophisticated line of remote wall-mounted controls, the Intellitek multifunction series.

An on-board diagnostic LED helps find problems quickly and efficiently. For example, the LED can be used to signal a broken or shorted electronic wall control wire.

**CONTINUOUS/VENTILATION MODE** — In this mode of operation, both fans are operating and exchanging air with the outside. The heat recovery ventilator constantly exchanges the air at the selected rate, either at low or medium speed, and switches to high speed when activated by an accessory remote control. The low and medium fan speed selection will cause the unit to operate in continuous exchange mode at an exchange rate of 35% and 50% maximum airflow rating respectively. Continuous mode is recommended, since pollutants are slowly but constantly being generated in the house. See Fig. 27.

**INTERMITTENT/STANDBY MODE** — The system is always on standby and operates at high speed when activated by an accessory remote control. Standby should be selected if the user wishes to stop the unit from continuous exchange. It is recommended that the Standby mode only be used if the system is equipped with an accessory external control, in which case, the unit would activate to High fan speed, until the control is satisfied and then return to standby (off). See Fig. 28.

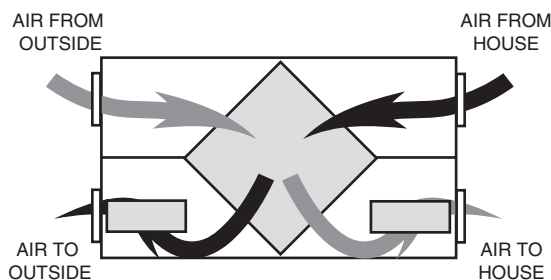


Fig. 27 — Continuous Mode

\* NO EXCHANGE OF AIR

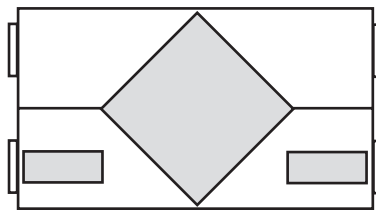


Fig. 28 — Intermittent Mode

## MAINTENANCE

### ⚠ WARNING

Make sure ERV is unplugged before performing any maintenance. Injury from electric shock could result.

A yearly inspection is recommended to ensure the efficiency and trouble-free use of the ERV. Verify the different operating modes.

**Motor** — The motors are factory balanced and lubricated for life. They require no maintenance.

**Chassis** — The inside of the unit should be vacuumed yearly. Be careful not to damage any of the mechanical components and electrical connections.

**Condensation Panel** — The condensation panel should be cleaned yearly.

**Outside Hoods** — The outside hoods need to be checked every season to make sure there are no debris, leaves, or insects blocking the airflow. Check regularly that there are no pollutants near the intake hood. Make sure the hoods are clear of any snow accumulation during the winter months.

**Filters** — The filters need to be checked and cleaned every three months or when they appear dirty. This unit has two filters.

To clean, remove the filters and vacuum. If the filters still appear dirty, they can be washed in warm water and mild detergent. Replace the filters if they become too soft after washing. The filters should be replaced yearly or when they can no longer be cleaned properly. The metal electrostatic filter may need to be changed after washing a few times.

**Enthalpic Core** — Clean the enthalpic core annually or as needed with a vacuum cleaner. Use a soft brush attachment. Make sure the filters on the unit are cleaned. Failure to clean or use filters may damage the enthalpic core and void the warranty.

**NOTE:** The use of the enthalpic core in adverse environment conditions such as dust, oil mist, excessive kitchen grease, corrosive fumes, organic solvents, paint or any other harmful chemicals can damage the enthalpic core and void the warranty. The use of the enthalpic core in adverse weather conditions such as in freezing climates will damage the enthalpic core and void the warranty.

## TROUBLESHOOTING

See Table 2 for troubleshooting.

**Table 2 — Troubleshooting**

PROBLEM	CAUSE	SOLUTION
Air is Too Dry	Dehumidistat control is set too low.	Increase the desired level of humidity. Change ventilation mode from continuous mode to standby.
	ERV out of balance.	Balance ERV.
Air is Too Humid	Dehumidistat control is set too high.	Reduce the desired level of humidity. Use continuous exchange mode.
	Sudden change in temperature.	Wait until outside temperature stabilizes (winter). Heating will also improve humidity of air.
	Storing too much wood for heating.	Store majority of wood outside. Even dried, a cord of wood contains more than 20 gallons of water.
	Dryer vent exhaust is inside home.	Arrange outside vent for dryer.
	Poor air circulation near windows.	Open curtains or blinds. Bay or bow windows may require additional air circulation.
	ERV out of balance.	Balance ERV.
	Basement door is closed.	Open the door or install a grille on the door.
Persistent Condensation on Window	Improper adjustment of dehumidistat control.	Reduce the desired level of humidity. Use continuous exchange mode.
	ERV out of balance.	Balance ERV.
Poor Airflow	1/4-in. mesh on the outside hoods is plugged.	Clean exterior hoods or vents.
	Filters plugged.	Remove and clean filter.
	Core obstructed.	Remove and clean core.
	House grilles closed or blocked.	Check and open grilles.
	Dampers are closed if installed.	Check and open dampers.
	Poor power supply at site.	Have electrician check supply voltage at house.
	Ductwork is restricting ERV operation.	Check duct installation.
	Improper speed control setting.	Increase the speed of the ERV.
ERV airflow improperly balanced.	Have contractor balance ERV.	
Supply Air Feels Cold	Poor location of supply grilles. Airflow may irritate the occupant.	Locate the grilles high on the walls or under the baseboards. Install ceiling mounted diffuser or grilles so as not to directly vent the supply air on the occupant. Turn down the ERV supply speed.
	Outdoor temperature extremely cold.	A small duct heater (1 kW) can be used to temper the supply air. Placement of furniture or closed doors is restricting the movement of air in the home. If supply air is ducted into furnace return, the furnace fan may need to run continuously to distribute ventilation air comfortably.
Condensation in Insulated Duct to the Outside	Incomplete vapor barrier around insulated duct.	Tape and seal all joints. Ensure that the vapor barrier is completely sealed.
	Hole or tear in outer duct covering.	Tape any holes or tears made in the outer duct covering. Ensure that the vapor barrier is completely sealed.

LEGEND

**ERV** — Energy Recovery Ventilator

**ENERGY RECOVERY VENTILATORS  
LIMITED 5-YEAR WARRANTY — PARTS  
7-YEAR WARRANTY — MOTOR  
LIMITED 5-YEAR WARRANTY — CORE**

**MULTI-YEAR WARRANTY** — This CARRIER CORPORATION product is warranted to be free from defects in material and workmanship under normal use and maintenance for a period of 5 years for parts, 7 years for the motor, and a limited 5 years for the core from the date of original installation. A new or remanufactured part to replace the defective part will be provided without charge for the part itself, through a qualified servicing CARRIER CORPORATION dealer or service, PROVIDED the defective part is returned to our distributor. The replacement part assumes the unused portion of the warranty.

**THIS WARRANTY DOES NOT INCLUDE ANY ADDITIONAL LABOR ALLOWANCE OR OTHER COSTS**, incurred for diagnosis, repairing, removing, installing, shipping, servicing, or handling of either defective parts or replacement parts. SUCH COSTS MAY BE COVERED BY a separate warranty provided by the installer.

**LIMITATIONS OF WARRANTIES** — ALL IMPLIED WARRANTIES (INCLUDING IMPLIED WARRANTIES OF MERCHANTABILITY) ARE HEREBY LIMITED IN DURATION TO THE PERIOD FOR WHICH THE LIMITED WARRANTY IS GIVEN. THE EXPRESSED WARRANTIES MADE IN THIS WARRANTY ARE EXCLUSIVE AND MAY NOT BE ALTERED, ENLARGED, OR CHANGED BY ANY DISTRIBUTOR, DEALER, OR OTHER PERSON WHATSOEVER.

**CARRIER WILL NOT BE RESPONSIBLE FOR:**

1. Normal maintenance as outlined in the installation and servicing instructions or owner's manual including cleaning and/or replacement of filters, media or electronic cells.
2. Damage or repairs required as a consequence of faulty installation or application by others.
3. Failure to start due to voltage conditions, blown fuses, open circuit breakers or other damages due to the inadequacy or interruption of electrical service.
4. Damage or repairs needed as a consequence of any misapplication, abuse, improper servicing, unauthorized alteration, or improper operations.
5. Damage as a result of floods, winds, fires, lightning, accidents, corrosive atmosphere, or other conditions beyond the control of CARRIER CORPORATION.
6. Damage as a result of using the Energy Recovery Ventilator unit in freezing weather conditions.
7. Parts not supplied or designated by CARRIER CORPORATION.
8. CARRIER CORPORATION products installed outside the continental U.S.A., Alaska, Hawaii, and Canada.
9. ANY SPECIAL INDIRECT OR CONSEQUENTIAL PROPERTY OR COMMERCIAL DAMAGE OF ANY NATURE WHATSOEVER. Some states do not allow the exclusion of incidental or consequential damages, so the above limitation may not apply to you.

---

Model No.

Unit Serial No.

---

Date of Installation

Installed by

---

Name of Owner

Address of Installation

---





---

Manufacturer reserves the right to  
discontinue, or change at any time,  
specifications or designs without notice  
and without incurring obligations.

REPLACEMENT COMPONENTS DIVISION  
© CARRIER CORPORATION 2004 12-04  
PRINTED IN U.S.A.

LITERATURE NUMBER P707-7SI  
REPLACES: New  
CATALOG NUMBER 570-354